

DSA3217/3218 SERIES PRESSURE SCANNER

DIGITAL SENSOR ARRAY

OPERATION AND SERVICE MANUAL



SOFTWARE VERSION 1.17

Scanivalve

PREFACE

WARNINGS, CAUTIONS AND NOTES



WARNING

The WARNING! symbol indicates that danger of injury for persons and the environment and/or considerable damage (mortal danger, danger of injury) will occur if the respective safety precautions are not taken.



CAUTION

The CAUTION ! symbol indicate danger for the system and material if the respective safety precautions are not taken.



The ESD note symbol indicates that proper precautions for handling Electrostatic Sensitive Devices needs to be taken when performing the related operation. This includes the use of grounded work surfaces and personal wrist straps to prevent damage to sensitive electronic components.

WARRANTY

Scanivalve Corporation, Liberty Lake, Washington, hereafter referred to as Seller, warrants to the Buyer and the first end user that its products will be free from defects in workmanship and material for a period of twelve (12) months from date of delivery. Written notice of any claimed defect must be received by Seller within thirty (30) days after such defect is first discovered. The claimed defective product must be returned by prepaid transportation to Seller within ninety (90) days after the defect is first discovered. Seller's obligations under this Warranty are limited to repairing or replacing, at its option, any product or component part thereof that is proven to be other than as herein warranted.

Surface transportation charges covering any repaired or replacement product or component part shall be at Seller's expense; however, inspection, testing and return transportation charges covering any product or component part returned and redelivered, which proves

not to be defective, shall be at the expense of Buyer or the end user, whichever has returned such product or component part.

This Warranty does not extend to any Seller product or component part thereof which has been subjected to misuse, accident or improper installation, maintenance or application; or to any product or component part thereof which has been repaired or altered outside of Seller's facilities unless authorized in writing by Seller, or unless such installation, repair or alteration is performed by Seller; or to any labor charges whatsoever, whether for removal and/or reinstallation of the defective product or component part or otherwise, except for Seller's labor charges for repair or replacement in accordance with the Warranty. Any repaired or replacement product or component part thereof provided by Seller under this Warranty shall, upon redelivery to Buyer, be warranted for the unexpired portion of the original product warranty.

THIS WARRANTY IS IN LIEU OF AND EXCLUDES ALL OTHER WARRANTIES, EXPRESS OR IMPLIED, ARISING BY OPERATION OF LAW OR OTHERWISE, INCLUDING THE IMPLIED WARRANTIES OF MERCHANTABILITY AND FITNESS FOR A PARTICULAR PURPOSE, AND IN NO EVENT SHALL SELLER BE LIABLE FOR INCIDENTAL OR CONSEQUENTIAL DAMAGES.

In the event of a failure:

1) Notify Scanivalve Corporation, Customer Service Department. Include model number and serial number. On receipt of this information, service data or shipping instructions will be forwarded. This may be transacted by telephone or e-mail.

2) On receipt of shipping instructions, forward the product, transportation prepaid. Repairs will be made and the product returned.

3) All shipments should be made via "Best Way". The product should be shipped in the original packing container or wrapped in protective material and surrounded by a minimum of four (4) inches of a shock absorbing material.

TRADEMARKS ® AND COPYRIGHTS ©

Scanivalve is a registered trademark of Scanivalve Corporation.

All other brand and product names are trademarks or registered trademarks of their respective companies.

PACKAGING FOR SHIPMENT

If the product must be shipped, whether being returned to Scanivalve or relocated to another location it must be packaged properly to minimize the risk of damage. The recommended method of packing is to place the instrument in a container, surrounded on all sides with at least four inches of shock attenuating material such as Styrofoam peanuts.

IMPORTANT NOTICE

Please note that the product specifications and other information contained in this manual are subject to change without notice. Scanivalve Corporation makes an effort and strives to provide complete and current information for the proper use of the equipment. If there are any questions regarding this manual or the proper use of the equipment, contact Scanivalve Corporation.

CONTACT INFORMATION

If there are any questions or concerns regarding any Scanivalve product please do not hesitate to contact us at the following:

Scanivalve Corp.
1722 N. Madson Street
Liberty Lake, WA 99019
Telephone: (800)935-5151 (509)891-9970
Fax: (509)891-9481
scanco@scanivalve.com
www.scanivalve.com

Scanivalve Corporation is an ISO9001:2000 certified company.

[INTENTIONALLY LEFT BLANK]

TABLE OF CONTENTS

PREFACE	IV
Warnings, Cautions and Notes	iv
Warranty	iv
Trademarks ® and Copyrights ©	v
Packaging for Shipment	v
Important Notice	v
Contact Information	v
SECTION 1: SPECIFICATIONS	1
DSA3217	1
DSA3218	2
SECTION 2: INTRODUCTION	5
General Description	5
Module Overview	5
DSA3217 Configurations	5
DSA3217/16Px	5
DSA3217/16Px - Dual Range	6
DSA3217/8DPx - Differential	6
DSA3217/16Px - Absolute	6
DSA3217/16Px - Individual Reference	7
DSA3217 Digital Out Option	8
DSA3218 Configurations	9
DSA3218/16Px	9
DSA3218/16Px - Dual Range	9
DSA3218/8DPx - Differential	9
DSA3218/16Px - Absolute	10
DSA3218 Heater Option	10
DSA3218 Cooling Kit Option	10
Environmental Considerations	11
SECTION 3: OPERATION	12
Unpack & Inventory	12
Mounting	12
Warm-up	12
Communications	12
Serial Communications	12
Ethernet Communications	13
Client/Host Options	13
PC - TCP/IP	13
PC - UDP	14
PC - ScanTel	14
PC - LabVIEW Configuration Utility	14
PC - LabVIEW Development Kit	14
PC - OPC Server	14
PC - HyperTerminal	14

Zero Offset Calibration	14
Quick Zero Jumper	15
Scanning	15
Scanning With An External Trigger	15
Hardware Trigger	15
Software Trigger	15
Freon Application Operations	16
SECTION 4: HARDWARE	17
Pneumatic Connections	17
Making 1/16" Tubulation Connections	17
Pressure Measurement (Px) Ports	18
Calibration (CAL) Port	18
Reference (REF) Port	18
Control 1 (CLT1) Port	18
Control 2 (CTL2) Port	18
Control Supply (CTL SUPPLY or CTL)	18
Return (RTN) Port	18
Purge Control (PRGCTL) Port	19
Purge Supply (PRG) Port	19
Power Requirements	19
Calibration Valve	19
SECTION 5: SOFTWARE	21
DSA Control and Configuration	21
DSA Commands	21
Command List	22
Calibrate	22
Calibrate Barometric Pressure	23
Calibrate Zero	24
Clear	24
Delete	25
Error	25
Fill	26
Insert	26
List All	27
List All Ranges	28
List Calibrate	29
List Delta	29
Digital Output	30
List Gain	30
List Identification	31
List Master	32
List MAXn Pressures	33
List MINn Pressures	33
List Negative Points	34
List Offset	34
List Scan	35
List Zero	35
Save	36
Scan	36

Scan Trigger	37
Set	37
Status	38
Stop	38
Upload	38
Version	39
Configuration Variables	40
Scan Variables (LIST S)	40
Average (AVG)	40
Binary Data (BIN)	40
Unit Conversion Factor (CVTUNIT)	40
Engineering Units (EU)	41
Data Format (FORMAT)	41
Frames Per Scan (FPS)	41
Page (PAGE)	42
Period (PERIOD)	42
QPKTS	42
Data Sample Source (SIM)	42
Time Stamp (TIME)	43
Scan Unit (UNITSCAN)	43
Enable External Trigger (XSCANTRIG)	43
Zero Correction (ZC)	44
Pressure Variables (LIST B, LIST H, LIST L and LIST N)	45
Absolute Enable (ABS _n)	45
Maximum Pressure (MAX _n)	45
Minimum Pressure (MIN _n)	45
Negative Calibration Points (NEGPTS _n)	45
Calibration Variables (LIST C)	46
Channel 1-8 Number of Negative Calibration Points (NEGPTSL)	46
Channel 9-16 Number of Negative Calibration Points (NEGTPSH)	46
Channel 1-8 Maximum Pressure (PMAXL)	46
Channel 9-16 Maximum Pressure (PMAXH)	46
Channel 1-8 Minimum Pressure (PMINL)	47
Channel 9-16 Minimum Pressure (PMINH)	47
Identification Variables (LIST I)	48
Serial Echo (ECHO)	48
Model (MODEL)	48
Ethernet Port (PORT)	48
Ethernet Host (HOST)	49
Pressure Deltas (LIST D)	49
Deltas (DELTA _n)	49
Temperature Offsets (LIST O)	49
Temperature Offset (TEMPB _n)	49
Temperature Gains (LIST G)	50
Temperature Gain (TEMPM _n)	50
Zero Offsets (LIST Z)	50
Zero Offset (ZEROn)	50
DSA Packet Definitions	51
Packet Types	51
Host to DSA Command Packet	51
DSA to Host Scan Packet (Not Used)	52
Status Packet	52

Scan Raw Packet	52
Scan EU Packet	53
Scan Raw with Time Packet	53
Scan EU with Time Packet	53
ASCII Packet	53
ASCII Packet Examples	54
Network Protocols Supported	54
DSA3200 Boot Parameters	54
Changing Boot Parameters (including IP address)	55
DSA3200 Buffer Description	56
DSA Network Configurations	56
Isolated Network	56
Integrated with System Network	56
Sub-Network with Gateway	56
DSA Network Addressing	57
SECTION 6: MAINTENANCE	59
Calibration	59
Full Calibrations	59
Field Calibrations	59
Zero Offset Calibration	59
DSA3200 Operating System Upload	60
DSA3200 Coefficient Upload	62
DSA3200 Sensor Replacement	63
DSA3200 General Checkout Procedure	66
APPENDIX	69
Appendix A: Temperature Compensated Pressure Conversion	69
Appendix B: Engineering Unit Conversion Constants	70
Appendix C: DSA3200 Error List	71
Boot/Initialization Errors	71
Set Configuration Variable Errors	71
Command Errors	72
Communication Errors	73
Appendix D: Software Change Log	74

[INTENTIONALLY LEFT BLANK]

[INTENTIONALLY LEFT BLANK]

SECTION 1: SPECIFICATIONS

DSA3217

Size (WxHxD)	2.86" x 3.40" x 7.08" (7.26cm x 8.64cm x 17.98cm)
Weight	6.4lbs (2.91kg)
Pressure Inputs:	16 (Standard) 8 (True Differential)
Input Fittings:	
Pressure Inputs	.063" tubulations
Control Inputs	.063" tubulations
Full Scale Ranges (standard)	
Differential	±10"WC, ±20"WC, 1 , 2.5, 5, 15, 30, 50, 100, 250, 500, 750 psid (2.5, 7, 17, 35, 100, 210, 345, 700, 1725, 3500, 5170 kPa)
Absolute	15, 30, 50, 100 and 250 psia (100, 210, 345, 700 and 1725 kPa)
Accuracy (after calibration)	
Differential	
10 inH ₂ O	±0.20% FS
20 inH ₂ O	±0.20% FS
1.0 psid	±0.12% FS
2.5 psid	±0.08% FS
5 to 500 psid	±0.05% FS
501 to 750 psid	±0.08% FS
Absolute (With CALB performed)	
15 psia	±0.05% FS
30 psia	±0.05% FS
50 psia	±0.05% FS
100 psia	±0.05% FS
250 psia	±0.05% FS
Overpressure Capacity (No damage)	
10 inH ₂ O	2 psi
20 inH ₂ O	2 psi
1 psid	5 psi
2.5 to 499 psid	200%
500 psid	150%
750 psid	113%

Maximum Reference Pressure	250 psid (1750 kPa) or sensor overpressure, which ever is less
Power Requirements	20 to 36 Vdc at 8 W
I/O and mating connectors	
Ethernet 10Base-T	RJ45
Trigger (bulkhead)	PTO2A-8-2P (Pre SN180)
Trigger (mating)	PTO6A-8-2S-SR (Pre SN180)
Trigger (bulkhead)	JTP02RE8-6P
Trigger (mating)	JTO1RE8-6S-SR
Power (bulkhead)	PTO2A-8-3P
Power (mating)	PTO6A-8-3S-SR
Communications Protocol	Ethernet IEEE802.3
Typical Data Acquisition Rate*	
TCP/IP ASCII	200 samples/chan/sec
UDP Binary	500 samples/chan/sec
*Maximum data output depends on network	
Typical Communications Rate	
Ethernet	10 Mbits/sec
RS232	1200 to 19200 BAUD (Configuration only)
Operating Temperature	0 to 60 °C
Compensated Range	0 to 69 °C
Total Thermal Error	Less than ±0.001% FS
Humidity	
Operation	5 to 95% RH, Non-Condensing
Storage	5 to 95% RH, Non-Condensing
Shock & Vibration	MIL-STD-810D Curve H
Shock	10G
Vibration	10G
Acceleration	10G
Media	Gasses compatible with Silicon, Silicone, Aluminum and Stainless Steel

DSA3218

Size (WxHxD) 4.08" x 6.97" x 9.0"
(10.36 cm x 17.70 cm x 22.86 cm)

Weight 9.78 lbs
(4.45 kg)

Pressure Inputs: 16 (Standard)
8 (True Differential)

Input Fittings:
Pressure Inputs 1/8" SwageLok®
(1/16" and 1/4" optional)
Control Inputs 1/8" SwageLok®
(1/16" and 1/4" optional)

Full Scale Ranges
Differential ±10"WC, ±20"WC, 1 ,
2.5, 5, 15, 30, 50, 100,
250, 500, 750 psid
(2.5, 7, 17, 35, 100, 210,
345, 700, 1725, 3500,
5170 kPa)
Absolute 15, 30, 50, 100 and
250 psia
(100, 210, 345, 700 and
1725 kPa)

Accuracy (after calibration)
Differential
10 inH₂O ±0.20% FS
20 inH₂O ±0.20% FS
1.0 psid ±0.12% FS
2.5 psid ±0.08% FS
5 to 500 psid ±0.05% FS
501 to 750 psid ±0.08% FS
Absolute (With CALB performed)
15 psia ±0.05% FS
30 psia ±0.05% FS
50 psia ±0.05% FS
100 psia ±0.05% FS
250 psia ±0.05% FS

Overpressure Capacity (No damage)
10 inH₂O 2psi
20 inH₂O 2psi
1.0 psid 5psi
2.5 to 499 psid 200%
500 psid 150%
750 psid 113%

Maximum Reference Pressure 250 psid (1750 kPa) or
sensor overpressure,
which ever is less

Power Requirements
No Heater 22 to 36 Vdc at 8 W
With Heater 22 to 36 Vdc at 35 W
(Drops to 8 W after
module has reached
temperature)

I/O and mating connectors
Ethernet 10Base-T PTO6A-4S-SR
Trigger (bulkhead) PTO2A-8-2P (Pre SN180)
Trigger (mating) PTO6A-8-2S-SR (Pre SN180)
Trigger (bulkhead) JTO02RE8-6P
Trigger (mating) JTO1RE8-6S-SR
Power (bulkhead) PTO2A-8-3P
Power (mating) PTO6A-8-3S-SR

Communications Protocol Ethernet IEEE802.3

Typical Data Acquisition Rate*
TCP/IP ASCII 200 samples/chan/sec
UDP Binary 500 samples/chan/sec
*Maximum data output depends on network

Typical Communications Rate
Ethernet 10 Mbits/sec
RS232 1200 to 19200 BAUD
(Configuration only)

Operating Temperature
Without Heater 0 to 60 °C
With Heater -55 to 60 °C
(Cooling kit recommended above 55 °C)

Compensated Range 0 to 69 °C

Total Thermal Error Less than ±0.001% FS

Humidity
Operation 5 to 95% RH, Non-Condensing
Storage 5 to 95% RH, Non-Condensing

Shock & Vibration
Shock MIL-STD-810D Curve H
10G
Vibration 10G

Acceleration 10G

Media Gasses compatible with Silicon,
Silicone, Aluminum and Stainless
Steel

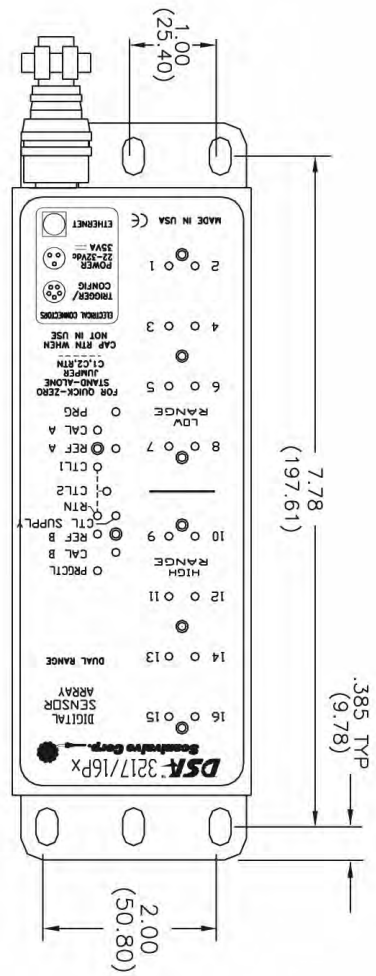
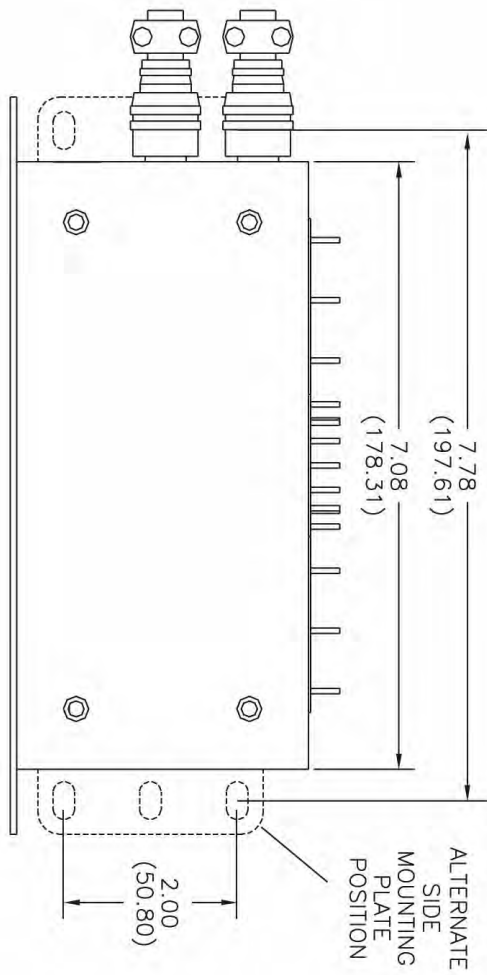
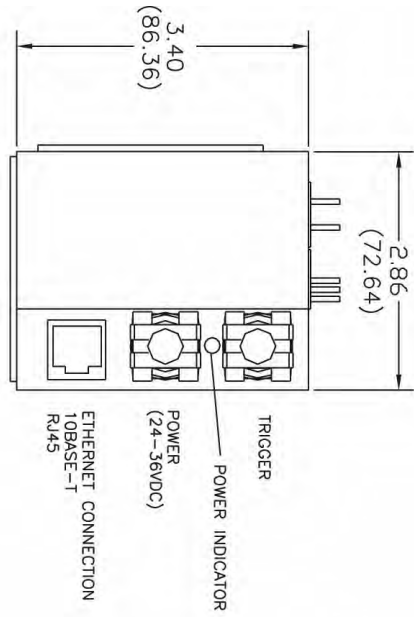

FIGURE 1.1 - DSA3217

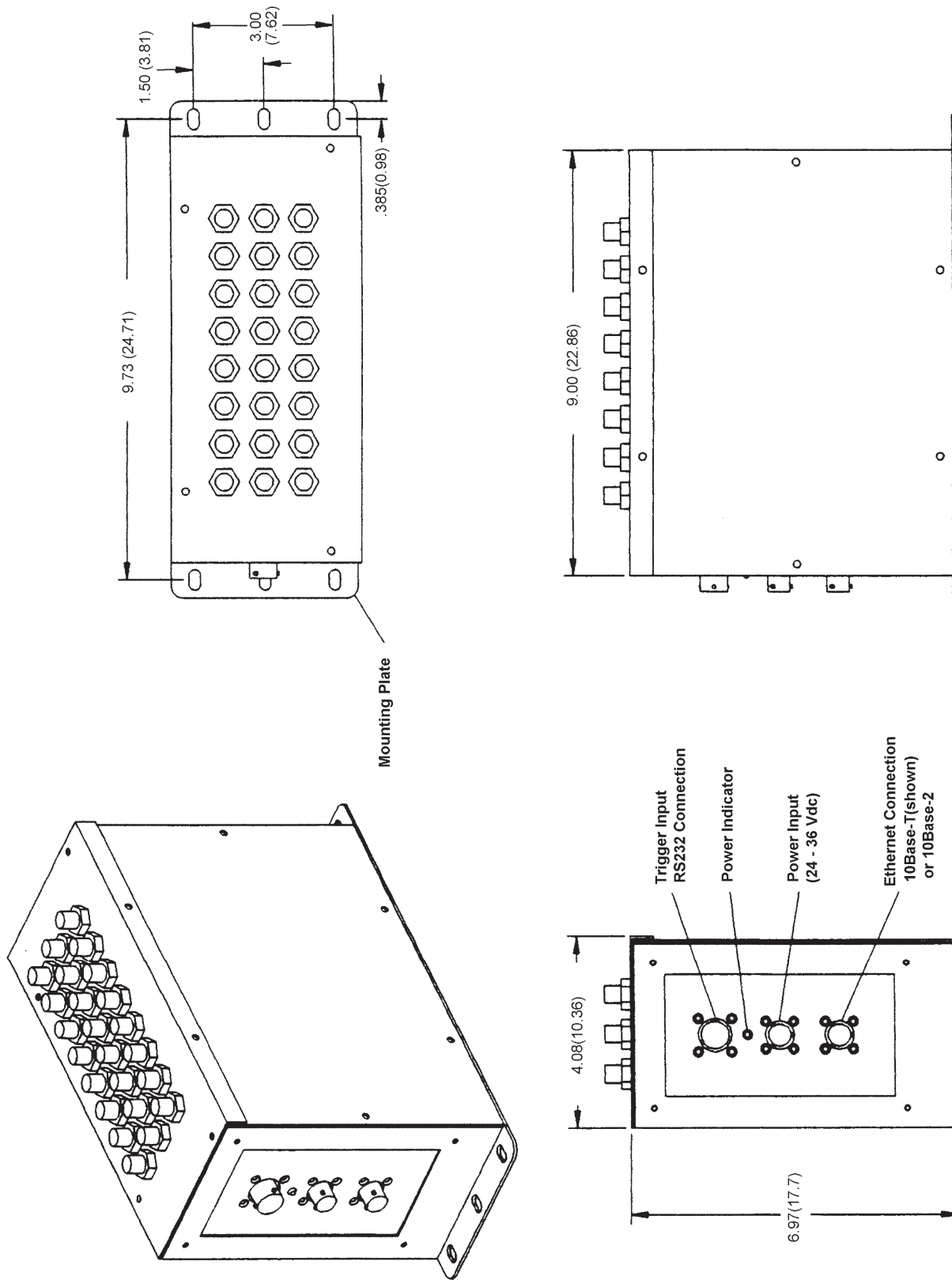

FIGURE 1.2 - DSA3218

SECTION 2: INTRODUCTION

GENERAL DESCRIPTION

The Digital Sensor Array (DSA) is a stand-alone electronic pressure scanner which can accept up to 16 pneumatic inputs. The module is specifically designed for use in applications where long calibration intervals, simple operation and high accuracy are required. Each DSA incorporates 16 individual, temperature compensated, piezoresistive pressure sensors, an A/D converter and a microprocessor. Each pressure sensor is characterized over pressure and temperature. This information is stored in EEPROM memory and enables the module to directly output corrected data in engineering units.

The sensors within each DSA3200 series module are arranged in groups of eight (8). Each block of eight (8) sensors has its own calibration valve. This calibration valve has four (4) modes of operation and allows the DSA module to perform measurement, calibration and purge functions. The four (4) modes are:

- Measure
- Calibrate
- Isolate
- Purge

The calibration valve mode is selected by applying 90-120 psi control pressure configurations unique for each operation mode. The DSA calibration valve utilizes “Normally Px” valve logic where the valve defaults to the measurement mode when no control pressures are applied.

MODULE OVERVIEW

The DSA3200 series is available in two basic configurations; the DSA3217 and the DSA3218. Both configurations offer 16 pressure inputs, both operate using the same software commands and both offer corrected data output directly in engineering units. The difference between the modules is the packaging and the intended applications. The DSA3217 is enclosed in a stainless steel, splash resistant enclosure intended for most laboratory, educational or controlled environments. The DSA3218 however, is enclosed in a stainless steel, splash resistant, shock mounted enclosure with Swagelok® fittings on all pneumatic connections. It is intended for applications such as gas turbine testing, flight testing, industrial applications and other more rugged environments.

In addition to the more rugged casing on the DSA3218 modules, additional options of a heater or a cooling kit are

offered. The heater option allows the module to be operated below the 0 °C temperature compensation range of the standard DSA3218 or DSA3217 modules. The cooling kit is recommended for applications where the ambient environment temperatures are likely to exceed 55 °C.

Both DSA3217 and DSA3218 modules are available with a variety of sensor configurations. The standard configuration is 16 channels of the same pressure range, however modules can be configured as dual-range units with 8 channels of one pressure range and 8 channels of another pressure range, ‘True-Differential’ measurement modules which provide 8 channels of differential pressure measurement, absolute pressure measurement modules or units with individual reference ports for each sensor (DSA3217 only).

DSA3217 CONFIGURATIONS

The DSA3217 is available in 5 basic configurations.

DSA3217/16Px

The basic DSA3217/16Px module provides 16 channels of the same ‘gauge’ pressure range sensors. These 16 pressure transducers are configured into two (2) groups of eight (8) each. Each group of eight (8) transducers shares a common calibration valve and a common reference manifold. Single range modules tie the two reference manifolds together and the two calibration valves to provide the user with a single reference and a single calibration port to connect to. Figure 2.1 depicts the top panel of a standard DSA3217/16Px.

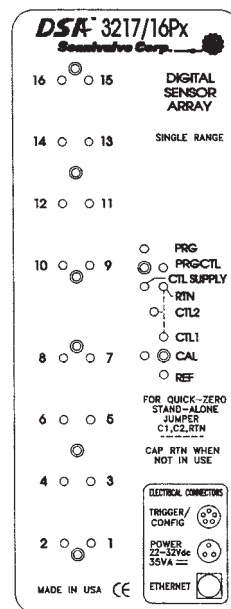

FIGURE 2.1 - DSA3217/16Px TOP PANEL

DSA3217/16Px - DUAL RANGE

The DSA3217/16Px module is available as a dual-range module, offering eight (8) channels of one pressure range and eight (8) channels of a different pressure range. Like a standard DSA3217, each group of eight (8) transducers share a common calibration valve and a common reference manifold. However, in dual range modules the reference manifolds and the calibration valves are not tied together and separate reference and calibration ports are provided on the top of the module. They are labeled CAL, CAL B, REF and REF B. Figure 2.2 depicts the top panel of a dual range DSA3217/16Px module.

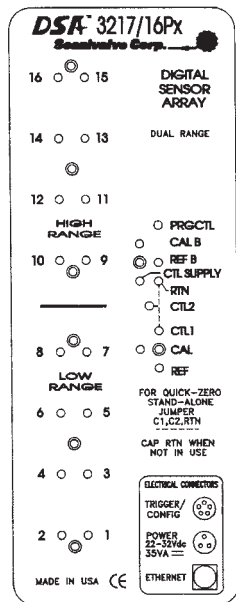

FIGURE 2.2 - DSA3217/16Px DUAL RANGE TOP PANEL

DSA3217/8DPx - DIFFERENTIAL

For differential pressure measurement applications, the DSA3217 can be configured with eight (8) differential pressure transducers. They are arranged into two (2) groups of four (4) transducers. Like the DSA3217/16Px, each group of transducers has a dedicated calibration valve that allows the input pressures to be blocked off during any calibration, including a zero offset calibration (CALZ). Figure 2.3 depicts the top panel of a DSA3217/8DPx module.

DSA3217/16Px - ABSOLUTE

The DSA3217/16Px module can be used for absolute pressure measurement when equipped with absolute pressure transducers. A calibration valve is provided for each group of eight (8) sensors. All sixteen (16) transducers are tied a single calibration port, except in the cases of dual-range absolute modules. Figure 2.4 depicts the top panel of a DSA3217/16Px absolute pressure module.

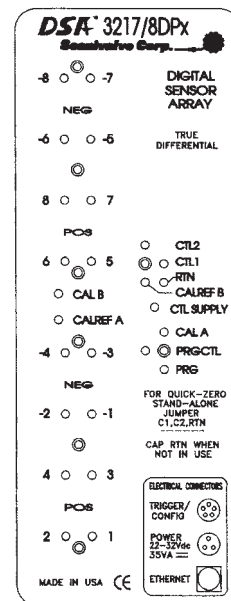

FIGURE 2.3 - DSA3217/8DPx DIFFERENTIAL TOP PANEL

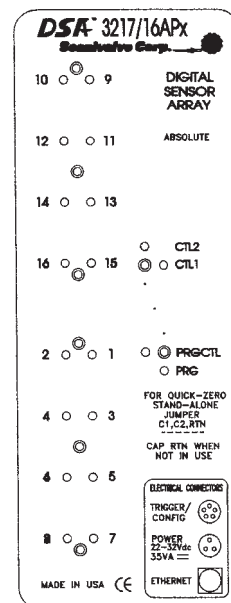

FIGURE 2.4 - DSA3217/16Px ABSOLUTE TOP PANEL

DSA3217/16Px - INDIVIDUAL REFERENCE

Both the standard DSA3217/16Px and Dual Range DSA3217/16Px are available with individual reference ports for each sensor. A calibration valve is provided for each group of eight (8) sensors, however unlike the standard DSA3217/16Px modules a separate reference port is provided for all sixteen (16) transducers. These individual reference ports are not controlled by the calibration valve.

This means that any calibration, including a zero offset calibration (CALZ) will have to be done with no pressure applied to the module. The individual reference modification is depicted in Figure 2.5 below.

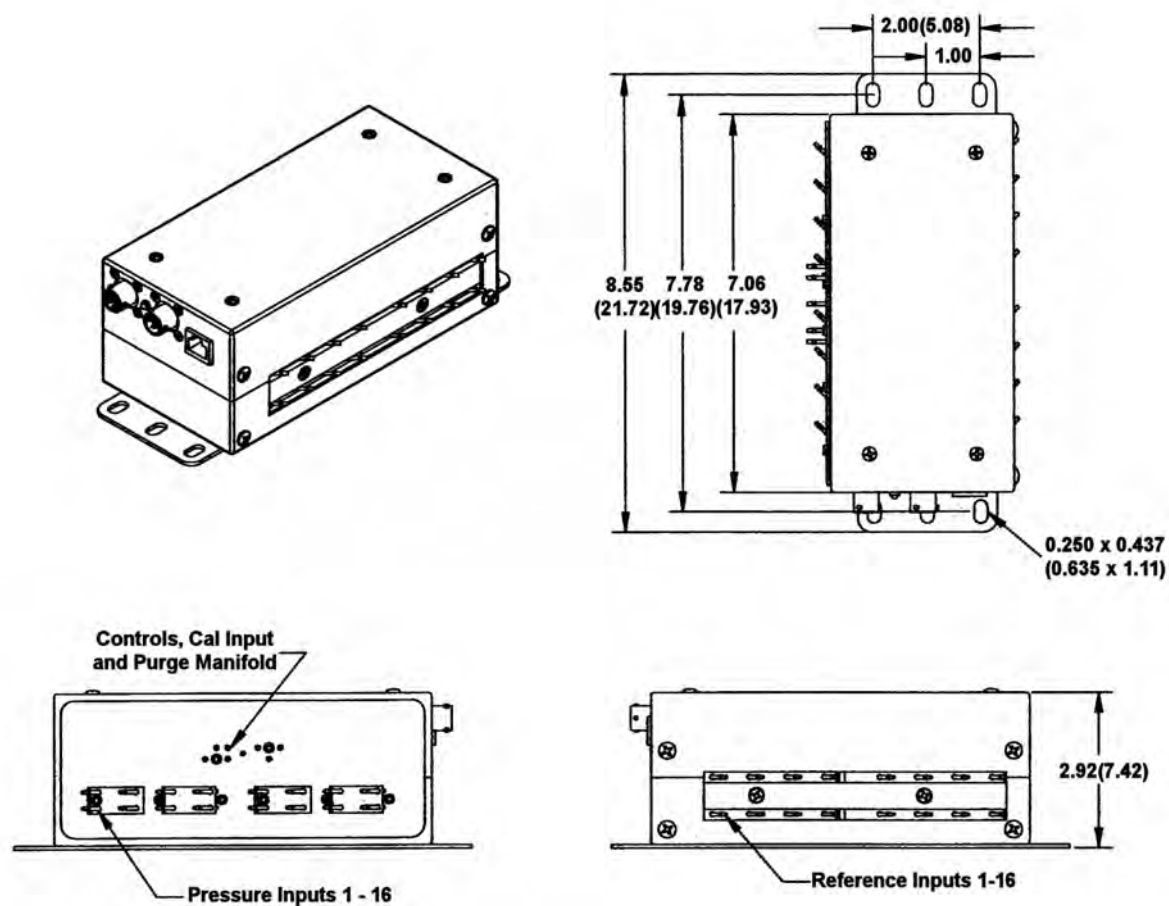
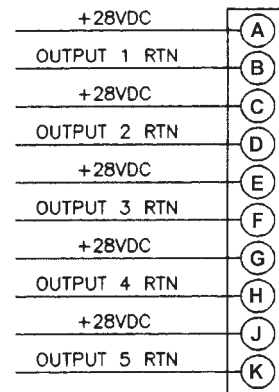

FIGURE 2.5 - DSA3217/16Px INDIVIDUAL REFERENCE

DSA3217 DIGITAL OUT OPTION

An additional option that can be added to DSA3217/16px, DSA3217/16px Dual Range, DSA3217/8dPx Differential pressure and DSA3217/16px Absolute pressure modules is the Digital Out controller. This is an external option that allows the DSA module to send up to five (5) Digital Output (DOU) signals. The Digital Out option is shown below in Figure 2.6.

The Digital Out option does increase the power requirements for the DSA3217. The power supply must be capable of supporting the standard power requirement of the DSA3217 and the power requirements for the Digital Out option. Each Digital Out being used requires 500mA @ 24Vdc. Figure 2.7 shows the wiring diagram of the Digital Out connector.



PT02A-12-10S

FIGURE 2.7 - DSA3217 DIGITAL OUTPUT WIRING DIAGRAM

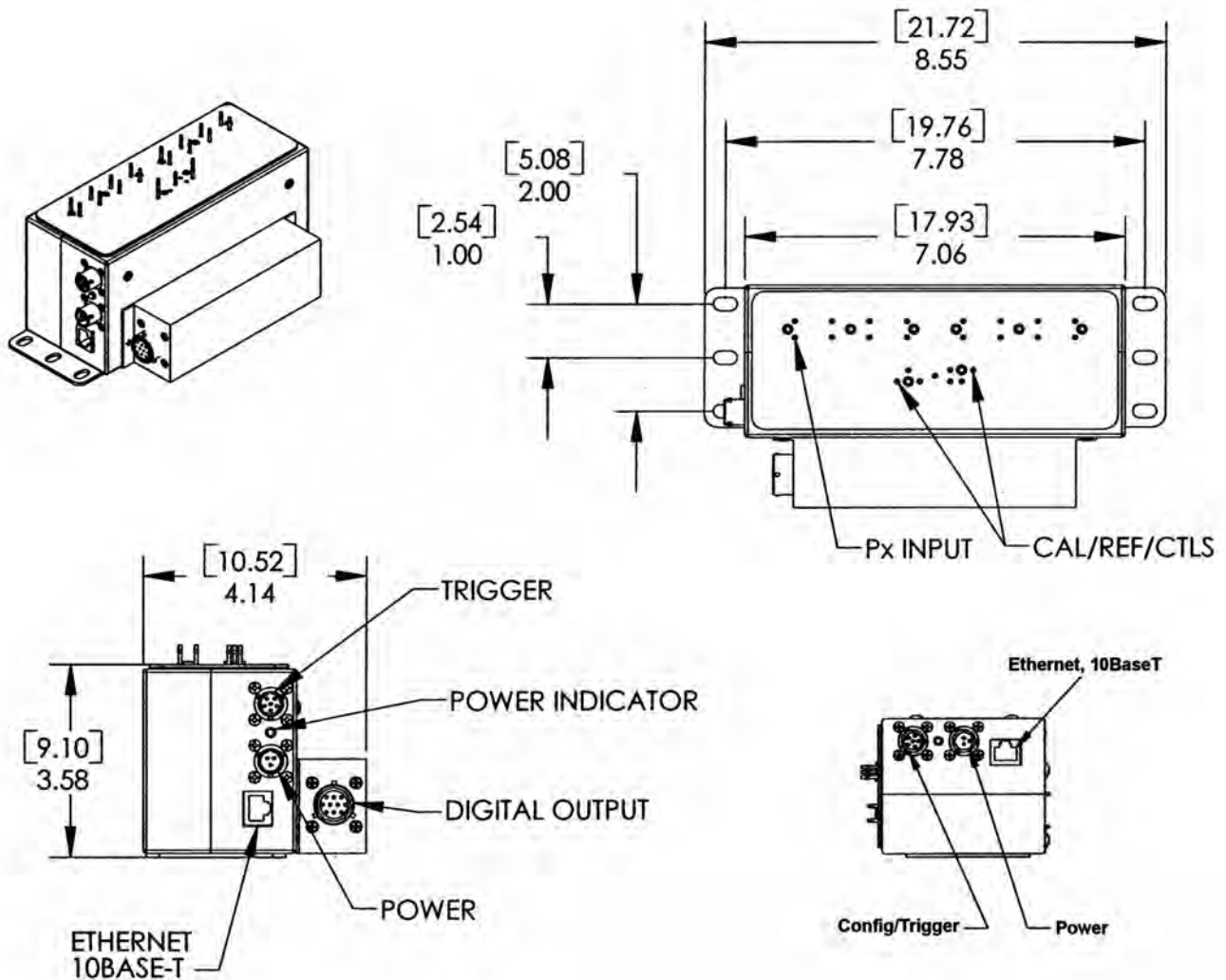

FIGURE 2.6 - DSA3217 DIGITAL OUT OPTION

DSA3218 CONFIGURATIONS

The DSA3218 is available in 4 basic pressure configurations and has 2 optional hardware configurations.

DSA3218/16Px

The basic DSA3218/16Px module provides 16 channels of the same ‘gauge’ pressure range sensors. These 16 pressure transducers are configured into two (2) groups of eight (8) each. Each group of eight (8) transducers shares a common calibration valve and a common reference manifold. Single range modules tie the two reference manifolds together and the two calibration valves to provide the user with a single reference and a single calibration port to connect to. Figure 2.8 depicts the top panel of a standard DSA3217/16Px.

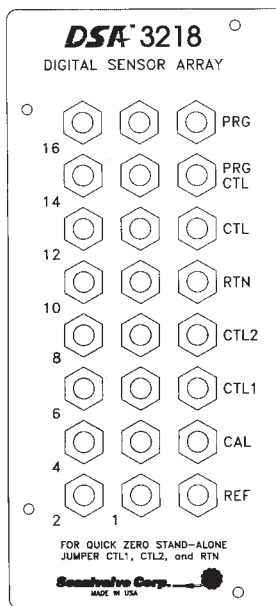

FIGURE 2.8 - DSA3218/16Px TOP PANEL

DSA3218/16Px - DUAL RANGE

The DSA3218/16Px module is available as a dual-range module, offering eight (8) channels of one pressure range and eight (8) channels of a different pressure range. Like a standard DSA3218, each group of eight (8) transducers share a common calibration valve and a common reference manifold. However, in dual range modules the reference manifolds and the calibration valves are not tied together and separate reference and calibration ports are provided on the top of the module. They are labeled CAL A, CAL B, REF A and REF B. Figure 2.9 depicts the top panel of a dual range DSA3218/16Px module.

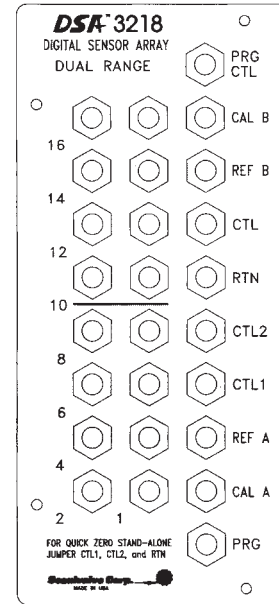

FIGURE 2.9 - DSA3218/16Px DUAL RANGE TOP PANEL

DSA3218/8DPx - DIFFERENTIAL

For differential pressure measurement applications, the DSA3218 can be configured with eight (8) differential pressure transducers. They are arranged into two (2) groups of four (4) transducers. Like the DSA3218/16Px, each group of transducers has a dedicated calibration valve. Figure 2.10 depicts the top panel of a DSA3218/8DPx module.

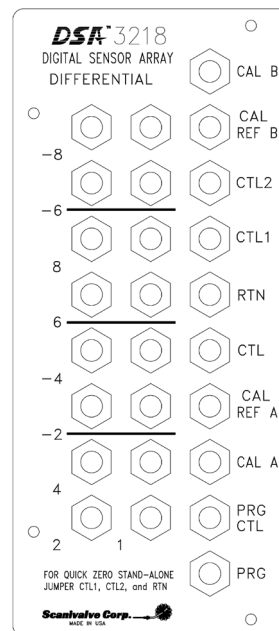

FIGURE 2.10 - DSA3218/8DPx DIFFERENTIAL TOP PANEL

DSA3218/16Px - ABSOLUTE

The DSA3218/16Px module can be used for absolute pressure measurement when equipped with absolute pressure transducers. A calibration valve is provided for each group of eight (8) sensors. All sixteen (16) transducers are tied a single calibration port, except in the cases of dual-range absolute modules. Figure 2.11 depicts the top panel of a DSA3218/16Px absolute pressure module.

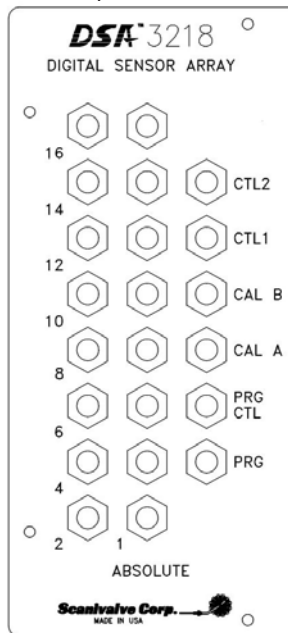

FIGURE 2.11 - DSA3218/16Px ABSOLUTE TOP PANEL

DSA3218 HEATER OPTION

The DSA3218 series module can be equipped with an internal heater for cold environment applications. The heater kit option increases the DSA3218's operational ambient temperature range to -55°C to 60°C by maintaining the internal temperature of the module at approximately +20°C. With a heater installed, the power requirements for the DSA3218 module increase to: 22-36Vdc @ 35W (28Vdc nominal). The power consumption of the module will decrease once the temperature of the module has stabilized.

DSA3218 COOLING KIT OPTION

For applications where the DSA3218 module must operate in ambient temperatures above the specified operating range, a cooling kit option is available. The cooling kit provides two (2) 3/8" Swagelok® fittings on the outside of the case and internal baffling to allow cool Nitrogen (or clean, dry air) to be circulated through the unit. The exact cooling flow requirements and the maximum operating temperature are different for each application, but for most applications the DSA3218 can be operated up to 80°C ambient temperature if sufficient cooling flow is provided. For most cases, 2-3 SCFM of 25°C should be supplied into the module.

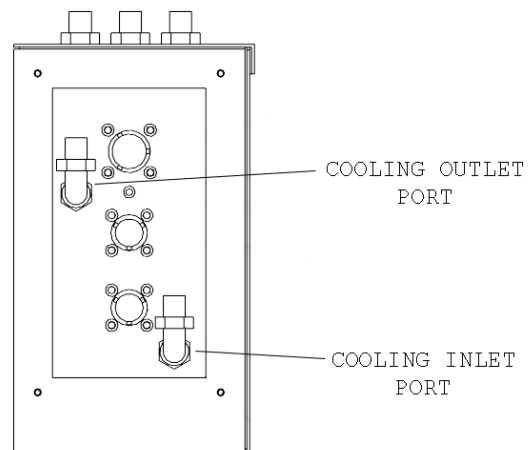
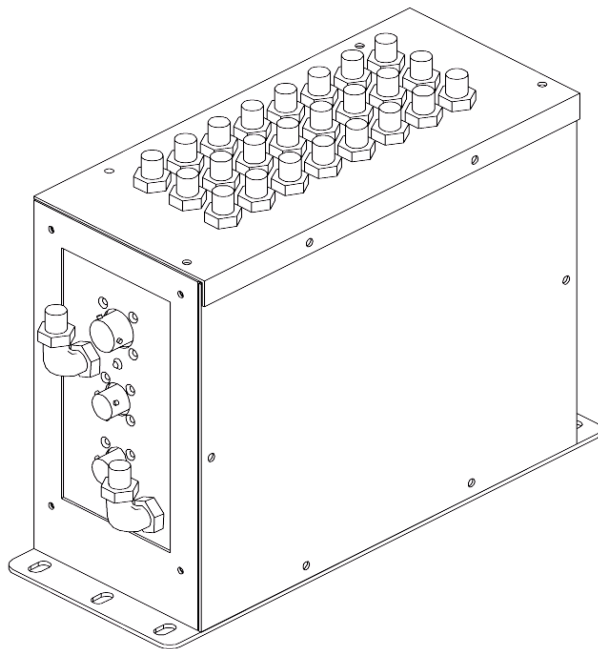

FIGURE 2.12 - DSA3218 COOLING KIT OPTION

ENVIRONMENTAL CONSIDERATIONS

Both the DSA3217 and DSA3218 modules are constructed with a rugged, corrosion resistant stainless steel case. This case is designed with withstand normal industrial, flight test, educational, wind tunnel or similar environments. The case is splash resistant but not water proof. If any moisture gets spilled or splashed on the DSA module, wipe it dry immediately to prevent damage to the module. The DSA module should not be mounted outdoors.

The DSA3218 module is designed for more rugged applications and incorporates internal shock mounts for vibration isolation, Swagelok® compression fittings on all pneumatic connections and robust, Bendix/Amphenol connectors for power, serial and Ethernet connections.

Both DSA modules include a heavy-duty mounting plate and can be mounted in any orientation. Once mounted, a zero offset calibration (CALZ) can be performed to remove any offset caused by the module orientation.

The DSA module should not be mounted in a location where it may be subjected to extreme temperature shifts or ambient temperatures outside of the specified operating range of the module. Keep in mind that the internal temperature of the module will run several degrees warmer than ambient temperature.

SECTION 3: OPERATION

UNPACK & INVENTORY

When you first unpack the DSA module, begin by inspecting and inventorying the contents of the package. If any visible damage is immediately noticed or if any contents are missing, contact Scanivalve before proceeding. Standard modules are shipped with the following contents as a minimum:

1. DSA3217 or DSA3218 module
2. Certificate of calibration
3. Full calibration report CD
4. DSA resource CD
5. Quick-zero jumper
6. Trigger/configuration cable connector
7. Power cable connector
8. Ethernet cable connector (DSA3218 only)

MOUNTING

The DSA module comes with a 3/32" (2.4mm) mounting plate attached to the bottom. This accepts mounting hardware up to 1/4" (6.4mm) in diameter. For added flexibility, the mounting plate on DSA3217 modules can be removed from the bottom of the module and mounted on the side of the module. The DSA module can be mounted in any orientation as any offsets caused by gravity will be removed by a zero offset calibration (CALZ). Ensure that the DSA module is mounted in an environment that conforms to the requirements described in "*Environmental Considerations*" on page 11.



CAUTION

CAUTION! Mounting the DSA module inadequately or in an environment that does not conform to the recommendations can result in permanent damage to the module.

WARM-UP

After applying power to the DSA module, a minimum of 30 minutes before collecting data is required to allow the module temperature to become stable. It is recommended that if time allows, the warm-up period should be extended to one hour for most applications.

COMMUNICATIONS

The DSA module is designed primarily for Ethernet communications. This provides a means to configure the DSA module as well as scan and collect data from the module. A serial RS-232 port is also provided. The serial connection

is designed to be used to configure the module, upload operating system upgrades and provide emergency communications. Several important module variables can be configured through the serial port, but possibly the most important is the Ethernet IP address. The only way to change the IP address of the module is through the serial port. See "Changing Boot Parameters (including IP address)" on page 55 for step by step instructions to change the module's IP address.

SERIAL COMMUNICATIONS

Every DSA3200 module has an RS-232 serial output. It is available through the 'Serial Communications/Trigger' connector on the front face of the module. For both DSA3217 and DSA3218 modules, the bulkhead connector on the module is an Amphenol JTP02RE8-6P (or PT02A-8-2P on serial numbers pre 180). All DSA modules are shipped with a mating connector (Amphenol PT06A-8-2S-SR pre SN:180 or Amphenol JTO1RE8-6S-SR post SN:180) that can be used to fabricate a Serial Communications/Trigger cable. Alternately, a Serial Communication/Trigger cable can be ordered from Scanivalve using the Scanivalve part number 155829.

The wiring diagram for the RS-232 output is shown below. The cable wiring must connect the Tx output from the host computer to the Rx input of the DSA module. Also, the RX input of the host computer must connect to the Tx output of the DSA module.

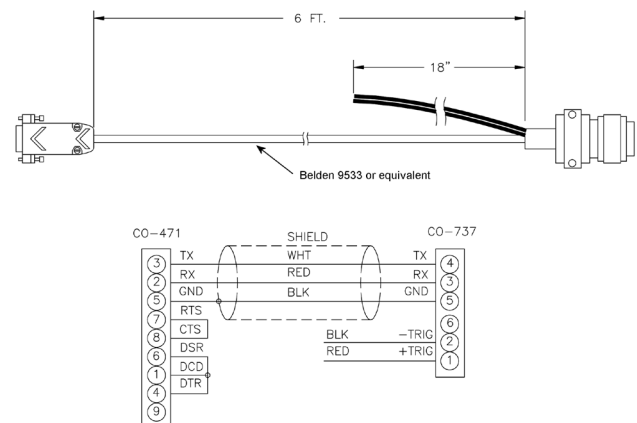

FIGURE 3.1 - SERIAL COMMUNICATION/TRIGGER CABLE

Settings for establishing a serial connection to the DSA module are as follows:

- Bits per second: 9600 BAUD
- Data bits: 8
- Parity: none
- Stop bits: 1
- Flow control: none

The Serial Communications port also serves as the input for the external scan trigger. For more information on externally triggering scans, see “Scanning With An External Trigger” on page 15.

For information on changing the boot parameters including the module’s Ethernet IP address, see “Changing Boot Parameters (including IP address)” on page 55.

ETHERNET COMMUNICATIONS

The primary means of communication with the DSA3217 and DSA3218 module is the 10Base-T Ethernet port. All DSA3217 modules use a standard RJ-45 Ethernet port. For added ruggedness, all DSA3218 modules use a Amphenol PT06A-8-4S-SR connector for the Ethernet connection instead of a standard RJ-45. Shielded Category 5 cable or better is recommended for all Ethernet connections. The Ethernet cable used will need to be either a straight through (pin to pin) cable or a crossed cable depending on the Ethernet network structure being used. A straight cable will be used if the DSA module is being connected to the host computer through a network hub or switch. If the DSA module is being connected directly to the network port on the host computer, a crossed Ethernet cable must be used.

Ethernet cables for the DSA3218 modules can be ordered from Scanivalve in both the straight (P/N: 155820) or crossed (P/N: 155859) configuration in any length up to 100 feet (30 meters).

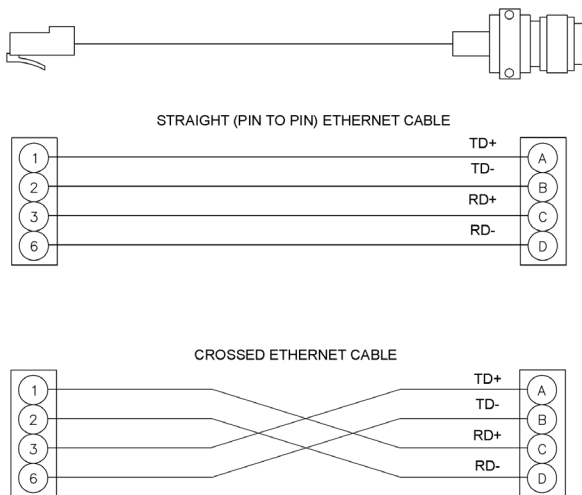

FIGURE 3.2 - 10BASE-T ETHERNET CABLES

Before an Ethernet connection can be established the IP address need to be configured. In order to be compatible, the IP address of the module and host computer must share the first two octets. The third and fourth octets of the IP address is variable, although it is recommended that the third octet also be shared between the host computer and the module.

Example of matching the first three octets (recommended):

- Host computer: 191.30.80.100
- DSA module: 191.30.80.125

Example of matching the first two octets:

- Host computer: 191.30.1.100
- DSA module: 191.30.80.125

The IP address of a Windows host computer can be changed under:

- Control Panel -> Network Connections -> Local Area Network -> Properties -> Internet Protocol (TCP/IP) -> Properties.

For information on changing the DSA module’s IP address, see “Changing Boot Parameters (including IP address)” on page 55.

CLIENT/HOST OPTIONS

Once the module has been connected and the IP address has been configured, communications can be established with the DSA module. Communications can be made through several software packages including:

- PC - TCP/IP
- PC - UDP
- PC - ScanTel (Scanivalve PN: 155406-01)
- PC - LabVIEW Configuration Utility (Scanivalve PN: 155384-01)
- PC - LabVIEW Development Kit (Scanivalve PN: 155385-01)
- PC - OPC Server (Scanivalve PN: 155282-01)
- PC - Windows HyperTerminal

PC - TCP/IP

The user may write their own TCP/IP interface using the software specification portion of this manual. This interface should allow the user to:

- Issue commands to any or all DSA modules on the network.
- Display returned information or scan data from the DSA module(s).
- Write returned information or scan data to the client/host in TCP/IP format.
- Determine the addresses of DSA module(s) on the network.

PC - UDP

The user may write their own UDP interface using the software specification portion of this manual. This interface should allow the user to:

- Issue commands to any or all DSA modules on the network.
- Display returned information or scan data from the DSA module(s).
- Write returned information or scan data to the client/host in UPD format (no handshaking).
- Determine the addresses of DSA module(s) on the network.

PC - SCANTEL

ScanTel a free communications utility designed by Scanivalve to communicate with Scanivalve products including DSA modules. It is a text based, command line program that allows users to connect to a single DSA module and modify the configuration variables, upload or download coefficients and collect data in both TCP/IP and UDP format.

PC - LABVIEW CONFIGURATION UTILITY

The Scanivalve LabVIEW Configuration Utility is software package that offers a very intuitive and simple way to connect to and modify all of the DSA module's configuration variables. It also allows the user the ability to upload a configuration file and scan and collect data. The scanning and data collection is limited to 5Hz due to the graphic nature of the program. The LabVIEW Configuration Utility is based on a LabVIEW 2009 runtime which is include with the installation disk.

PC - LABVIEW DEVELOPMENT KIT

The Scanivalve LabVIEW Development Kit is for users desiring to customize a LabVIEW driver for DSA modules. The Development Kit is compatible with LabVIEW 8.2, 8.6 and 2009. The LabVIEW Configuration Utility is included with the Development Kit.

PC - OPC SERVER

Scanivalve has written an OPC Server driver to interface a PC running in an OPC environment with a DSA module. This program is designed to operate in Windows 2000 or Windows XP.

PC - HYPERTERMINAL

HyperTerminal is a Windows program included as part of Windows 2000, XP and Vista Operating Systems. This program permits a user to connect to a single DSA module, modify the configuration variables, upload or download coefficients and collect data. HyperTerminal provides a means for both Serial RS-232 and Ethernet connections. It is a text based command line program.

ZERO OFFSET CALIBRATION

The DSA's internal calibration valve incorporates a zero offset correction feature (Quick Zero). This feature provides a simple and quick means to correct for the minor zero drift problem inherent to piezoresistive sensors. Even with pressure applied to the Px ports, the calibration valve can be configured into the 'Quick Zero' calibration mode which pneumatically shorts the positive and the negative side of the reference together. At that point, with the sensor at its natural zero state the offset can be read and recorded. This can then be factored into the engineering units and mathematically removed. All this is done in under 10 seconds with the simple command 'CALZ'. In order for the calibration valve to successfully switch, 90-120 psi of control pressure must be supplied to the 'CTL SUPPLY' port (or just 'CTL' on some DSA3218 modules) and the quick zero jumper must be installed.

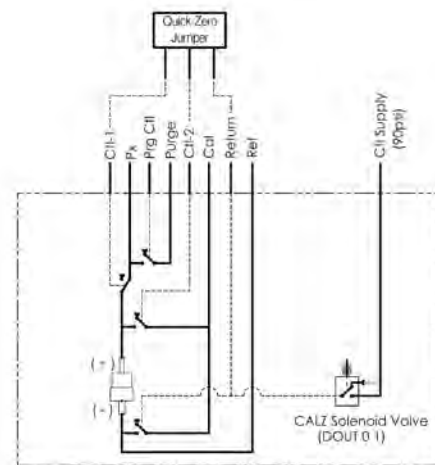

FIGURE 3.3 - QUICK ZERO LOGIC

Absolute pressure modules have a similar zero offset correction feature. The command 'CALB' can be entered followed by the current known barometric pressure to perform a zero offset calibration of absolute pressure modules. More information on both the 'CALZ' and the 'CALB' software commands can be found in "Calibrate Zero" on page 24 and "Calibrate Barometric Pressure" on page 23 respectively.

Due to the nature of the piezoresistive sensors used in the DSA modules, it is recommended that a 'Quick Zero' be performed at least daily. Performing a 'Quick Zero' more often will not cause any problems and is encouraged. Keep in mind, if the temperature of the module changes more than 3 °C a fresh 'Quick Zero' should be performed.

Zero offset corrections becomes obsolete after several hours or after the module has changed temperatures so all zero offset calibration data is stored in volatile memory and is lost whenever the module power is cycled.

QUICK ZERO JUMPER

In order to perform a zero offset calibration 90-120 psi of control pressure must be individually applied to the CTL1 and the CTL2 control ports. In order to simplify the process, all DSA modules are shipped with a quick zero jumper. Installing the quick zero jumper to the 'RTN', 'CTL1' and 'CTL2' ports allows the internal calibration valves to be placed into the 'Quick Zero' configuration automatically. By simply applying 90-120 psi of control pressure to the 'CTL SUPPLY' (or 'CTL' on some DSA3218 modules) and calling the 'CALZ' or 'CALB' command, the DSA module automatically vents control pressure out of the 'RTN' port and to the 'CTL1' and 'CTL2' ports.

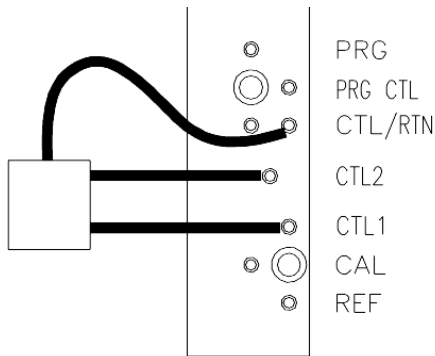

FIGURE 3.4 - QUICK ZERO JUMPER INSTALLATION

SCANNING

Once the DSA module has been installed, powered up and allowed to thermally stabilize data can be collected. There are several configuration variables that effect how the DSA module scans and how the data is output. The scan rate is controlled by two variables: 'period' and 'average' variables, the length of the scan sample is determined by the 'frames per scan' (FPS) variable and the data output format is determined by the 'format' variable. The DSA can be configured for 'free run' mode where after the 'SCAN' command is send the DSA module will scan continuously until the frames per scan (FPS) term is met, or it can be triggered to scan and output data upon receipt of a scan trigger (either external or a software trigger). The following is a list of commands that effect how the DSA collects data.

AVG	PAGE
BIN	PERIOD
CVTUNIT	TIME
EU	UNITSCAN
FORMAT	XSCANTRIG
FPS	ZC

More information on all of these configuration variables can be found in "Section 5: Software" on page 21.

To initiate scanning, simply send the command: 'SCAN'. If a scan trigger is not being used, data will begin to be output from the DSA module over the Ethernet connection. This data can be collected and recorded using one of the described in "Client/Host Options" on page 13. If a scan trigger is being used, after the 'SCAN' command is sent one frame of data will be output each time a scan trigger is received.

SCANNING WITH AN EXTERNAL TRIGGER

The DSA module can be triggered to scan with either a hardware or a software trigger.

HARDWARE TRIGGER

The external trigger input is optically isolated to prevent grounding problems. It is a TTL level, edge sensing device. It requires a minimum signal of 4.5Vdc @ 6.5mA (Units manufactured before 2009 may require 9Vdc triggers). It will accept voltages as high as 15Vdc. The external trigger will only be active if the XSCANTRIG variable is set to 1. When a 'SCAN' command is issued through the Ethernet connection, the module enters the scan mode and waits for a trigger. This module will return an averaged frame of data for each trigger pulse received. This will continue until the Frames Per Scan (FPS) term is met or until a 'STOP' command is issued. Trigger pulses are received through pins 1 (+Trig) and 2 (-Trig) of the 'Serial Communications/Trigger' connector on the front of the DSA module. More information on the 'Serial Communications/Trigger' connection can be found in "Serial Communications" on page 12.

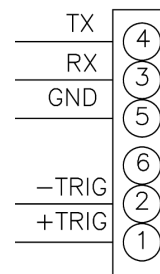

FIGURE 3.5 - TRIGGER WIRING

SOFTWARE TRIGGER

The software trigger will only be active if the software variable XSCANTRIG is set to 1. When a SCAN command is issued through the Ethernet connection, the module will enter the SCAN mode and wait for a trigger. An averaged frame of data will be output as soon as the TRIG command or a <TAB> character (9 HEX or Control I) is received. Data will be output with each successive trigger command. This will continue until the Frames Per Scan (FPS) variable value is met, or until a STOP command is issued.

PURGING

All DSA modules incorporate an internal calibration valve. One of the configurations of this valve allows for an 'isolate-purge' feature. This permits the pressure measurement (Px) lines to be purged with pressures up to 750 psi, whichever is less. This is a very useful feature when the DSA module is used in applications where corrosive gasses or moisture may be present in the input lines. By isolating the pressure sensors from the purge pressure, even low pressure DSA modules can be purged safely with high purge pressures.

In order to configure the DSA module for purge mode 90-120 psi of control pressure must be applied to the 'CTL1' 'CTL2' and 'PRG' ports. **The purge mode must be established in a set order in order to protect the sensor and calibration modules from damage.**

Configuring for purging:

1. Set the calibration valve for calibration mode by applying 90-120 psi of control pressure to both the 'CTL1' and 'CTL2' ports.
2. Apply 90-120 psi of control pressure to the 'CTLPRG' port.
3. Apply the purge pressure to the 'PRG' port.

Re-configuring after a purge:

1. Shut off the purge pressure feeding the 'PRG' port. Make sure to allow sufficient time for the input lines to stabilize. The specific time required will depend upon the physical layout and characteristics of the system.
2. Remove 90-120 psi control pressure from the 'CTLPRG' port.
3. Remove the 90-120 psi control pressure from the 'CTL1 and 'CTL2' ports.



CAUTION! Failing to follow the above procedure while entering or exiting the purge mode could allow the sensor to see the high purge pressure and could seriously damage the DSA module

FREON APPLICATION OPERATIONS

When using DSA 3018/3218 modules in Freon Applications special considerations must be taken. In order to prevent premature deformation of the seals within the DSA 3018/3218's valve, it is important to leave the module in the following 'dormant' state.

- Apply CTL2 and PRGCTL pressures
- Ensure no Px pressures are applied
- Freon present must be vaporized

Any time the module will be left inactive for a significant period of time it should be left in this state. Adhering to this procedure will help ensure long life and prevent any premature maintenance requirements.

SECTION 4: HARDWARE

PNEUMATIC CONNECTIONS

The DSA module has several different pneumatic connections on the top of the module. There are two basic types of pneumatic connections on each module: pressure measurement connections (Px) and configuration pressure connections (Control). The pressure measurement ports are the 16 ports labeled 1-16 (or 1 through 8 and (-)1 through (-)8 on differential pressure modules) on the top of the module. These ports are connected to the pressure transducers within the module. Also included in the pressure measurement ports are the CAL and REF ports. Dual range modules will have CAL A and CAL B, and REF A and REF B ports. These ports are used for applying known pressures during calibration, and reference pressures during normal data collection and calibrations. It is very important that all pressure measurement connects are completely leak tight. Any minor leak will cause an error in the measured pressure.

The control ports are the remaining ports on the top of the DSA module. These ports are used for configuring the module and for purging clean air through the module. All air supplied to the control ports needs to be instrument grade, clean dry air. Nitrogen is a very good alternative for when instrument grade air is not available.

All pneumatic connections on the DSA3217 module are 1/16" (1.6mm) stainless steel bulged tubulations. All pneumatic connection on the DSA3218 are 1/8" Swagelok® compression fittings. As an option, 1/16" or 1/4" Swagelok® are available.

MAKING 1/16" TUBULATION CONNECTIONS

Begin by applying a small amount of Scanivalve brown pipe sealant to the outside of the tubulation. Carefully slide the tubing over the outside of the stainless steel tubulation (Scanivalve's tubing push-on tool TPOTL-XXX makes this job easy). Ensure that the end of the Urethane, Nylon or Teflon tubing extends at least 1/16" beyond the bulge on the tubulation. Finally, slide the helical spring clamp over the outside of the tubing, ensuring that the spring clamp ends up over the bulge. Helical spring clamps are required for all pressure ports that will see over 50psi and they are highly recommended for all tubulation style pneumatic connections. When using Teflon tubing, spring clamps are required on all connections no matter what the measurement pressure is.

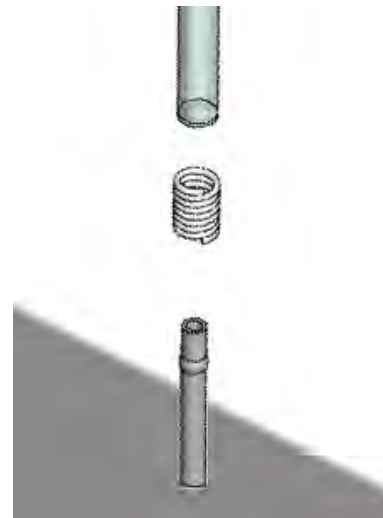

FIGURE 4.1 - TUBULATION PNEUMATIC CONNECTIONS

MAKING SWAGELOK® COMPRESSION CONNECTIONS

Each Swagelok® compression fitting includes 4 parts: the nut, the front ferrule, the back ferrule and the body. Squarely cut the end of the nylon or Teflon tubing being used. Slide the nut and both ferrules up on the tubing, then insert it all of the way into the Swagelok® body. Tighten the nut finger tight, to the point where the tube cannot be removed by hand. Finally, with a wrench tighten the nut 3/4 to 1 1/4 more turns. There is no need to tighten the nut any more than this.

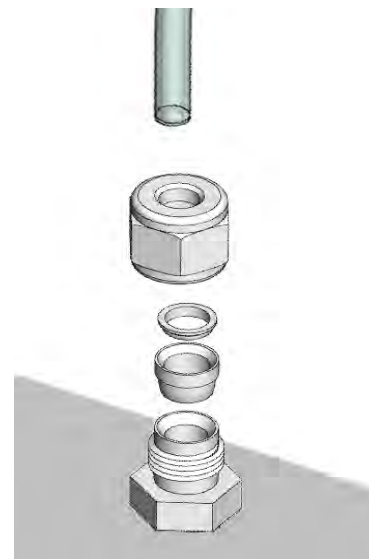

FIGURE 4.2 - SWAGELOK® COMPRESSION CONNECTIONS

PRESSURE MEASUREMENT (Px) PORTS

Each DSA module has 16 pressure measurement ports, or Px ports. They will be labeled 1-16, or for dual range units $\pm 1-8$. Each of these ports are connected to a discrete pressure transducer. If any Px ports are not being used, it is recommended that they be plugged to prevent dust or debris from clogging the port or contaminating the internal calibration valve.

CALIBRATION (CAL) PORT

For each pressure range the DSA module has, there will be a 'CAL' port. Most modules will only have one 'CAL' port, but dual range modules will have two (labeled 'CAL' and 'CAL B'). The 'CAL' port provides a means to apply a known calibration pressure to a single port and have it manifolded to all of the transducers of the related pressure range. During normal operations, with no control pressures applied this port is internally blocked off. Any pressure applied to the 'CAL' port will not reach the transducers unless the internal calibration valve has been configured to direct the calibration pressure to the transducers. For low pressure modules (below 5 psi) the 'CAL' port should be routed to a known, stable static location when not being used to apply calibration pressures. This ensures that when a zero offset calibration (CALZ) is performed no unwanted offsets are introduced.

REFERENCE (REF) PORT

For each pressure range the DSA module has, there will be a 'REF' port. Most modules will only have one 'REF' port, but dual range modules will have two (labeled 'REF' and 'REF B'). On differential pressure modules, the 'REF' port is labeled 'CAL REF'. There is no 'REF' port on absolute or individual reference pressure modules. The 'REF' port ties into a manifold that connects the back side (or negative side) or all transducers of the same pressure range together. During most applications, the 'REF' port of low pressure modules (below 5 psi) should be routed to a known, stable static location. This ensures that when a zero offset calibration (CALZ) is performed no unwanted offsets are introduced. During a calibration, positive pressures will be applied through the 'REF' port to perform the negative portion of the calibration.

CONTROL 1 (CTL1) PORT

Control 1 (CTL1) is the 'isolation' control. Applying 90-120 psi to the CTL1 port closes a normally open (flow) valve and configures the internal calibration valves into isolate mode, meaning that pressures applied to the pressure measurement ports (Px 1-16) will not reach the transducers. CTL1 controls both internal calibration valves simultaneously, they cannot be operated separately. Ensure that any control air applied to CTL1 is clean, dry instrument grade air or nitrogen.

CONTROL 2 (CTL2) PORT

Control 2 (CTL2) is the 'calibration' control. Applying 90-120 psi to the CTL2 port opens a normally closed (no flow) valve and configured the internal calibration valve into calibration mode, meaning that pressures applied to the 'CAL' port(s) will reach the transducers. CTL2 controls both internal calibration valves simultaneously, they cannot be operated separately. Ensure that any control air applied to CTL2 is clean, dry instrument grade air or nitrogen.

CONTROL SUPPLY (CTL SUPPLY OR CTL)

The Control Supply port (CTL SUPPLY on DSA3217, CTL on DSA3218) is only required when the quick zero jumper is being used. In this case, 90-120 psi is applied to the CTL Supply port and through the quick zero jumper is directed to the CTL1 and CTL2 ports to put the DSA module into zero offset calibration (CALZ) mode. This allows the user to remotely perform zero offset calibration (CALZ) as long as 90-120 psi is supplied to the CTL Supply port. For more information on the quick zero jumper, reference "Quick Zero Jumper" on page 15.

RETURN (RTN) PORT

Like the Control Supply port, the Return (RTN) port is only required when using the quick zero jumper. 90-120 psi control air that is supplied through the Control Supply port is switched internally within the module, and when commanded returned out of the Return port to be used to put the module into zero offset calibration (CALZ) mode. For this to function correctly, the quick zero jumper must be installed between the Return (RTN), Control 1 (CTL1) and Control 2 (CTL2) ports. For more detailed information on the quick zero jumper, reference "Quick Zero Jumper" on page 15.

PURGE CONTROL (PRGCTL) PORT

For applications where the pressure measurement ports (Px ports) may become plugged or contaminated, the DSA module is equipped with a purge function. Applying 90-120 psi to the purge control (PRGCTL) port and the control 1 port (CTL1) places the internal calibration valve into purge mode by opening the purge supply to the Px ports and isolating the sensors from the purge pressure. Like the other control pressures, ensure that any control air applied is clean, dry instrument grade air or nitrogen.



CAUTION! Applying PRGCTL after or without CTL1 applied can allow sensors to see the purge pressure potentially causing serious damage to the module.

PURGE SUPPLY (PRG) PORT

The purge supply (PRG) port is the input for the pressure that will be used to purge the pressure measurement (Px) lines. The supplied purge pressure can be up to 750 psi, and must always be clean, dry instrument grade air or nitrogen.

POWER REQUIREMENTS

The DSA3217 requires 28 ±8Vdc at approximately 8 W. This will remain constant while the module is operating normally. The DSA3218 requires 28 ±8Vdc at approximately 8 W. The power requirements for these modules increase to 28 ±8Vdc at approximately 35W if the optional heater is installed. The power requirements will drop when the module reaches the normal operating temperature. If the module is used in an environment where the ambient temperature is 0°C or less, power requirements could remain high.

The power connection is made through a three pin **Amphenol** PTO2A-8-3P connector located on the end of the module.

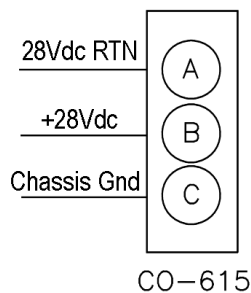

FIGURE 4.3 - POWER WIRING

CALIBRATION VALVE

Each DSA module has two internal calibration valves. The calibration valves can be configured using the three control pressure inputs on the DSA module (CTL1, CTL2 and CLTPRG). The two calibration valves cannot be operated independently. The calibration valves are configured such that no control pressures are required for normal measurement operations. The following tables outline the required control pressure input for each calibration valve configuration.

Standard DSA Calibration Valve configurations:

MODE	CTL1	CTL2	CLT*	PRGCTL
OPERATE				
CALIBRATE	90-120 psi	90-120 psi		
QUICK ZERO	90-120 psi	90-120 psi	90-120 psi	
PURGE	90-120 psi	90-120 psi		90-120 psi
ISOLATE	90-120 psi			

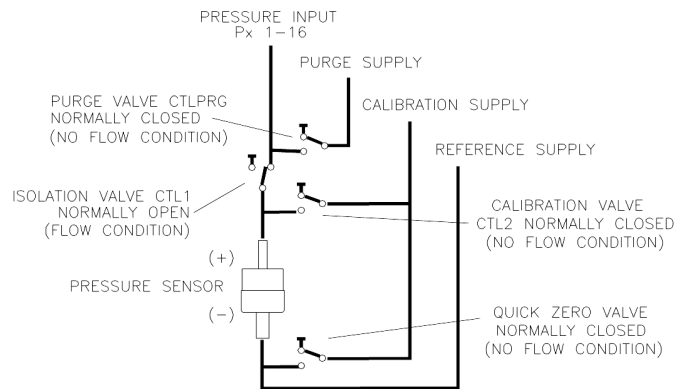

FIGURE 4.4 - STANDARD VALVE LOGIC

Absolute DSA Calibration Valve configurations:

MODE	CTL1	CTL2	PRGCTL
OPERATE			
CALIBRATE	90-120 psi	90-120 psi	
PURGE	90-120 psi	90-120 psi	90-120 psi
ISOLATE	90-120 psi		

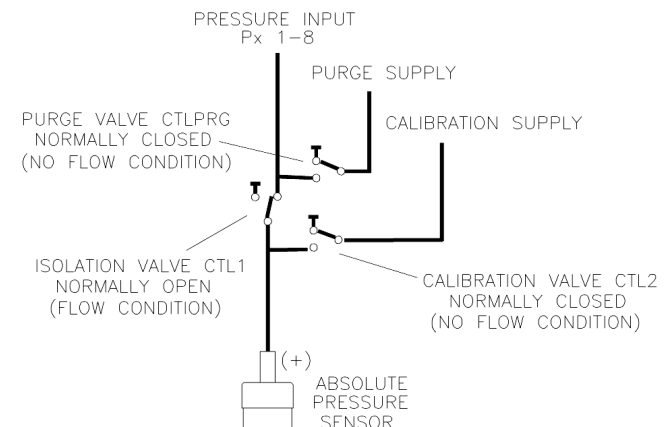

FIGURE 4.5 - ABSOLUTE VALVE LOGIC

[INTENTIONALLY LEFT BLANK]

SECTION 5: SOFTWARE

DSA CONTROL AND CONFIGURATION

The operation of a DSA module is controlled by sending commands to units selected by network addressing via the network. The DSA returns any data or information over the network to the requesting client/host.

The section on DSA Commands lists each command and explains its function.

DSA COMMANDS

The DSA software must run as embedded software on the DSA pressure scanner hardware. It performs the following general tasks:

1. Read and filter the raw A/D counts that represent pressure and temperature.
2. Convert the pressure A/D counts to user chosen pressure units.
3. Receive and execute commands from the Ethernet Link.
4. Allow the configuration to be saved through power down.
5. Output converted data, status, setup and calibration data over the Ethernet Link.
6. Set the DSA Physical Ethernet Address(MAC Address).
7. Protocol to be TCP/IP or User Defined Protocol.
8. Support the user in troubleshooting the DSA hardware and system.

TCP/IP does not guarantee that packet boundaries will be maintained between a host and a DSA module. Therefore, all commands from a host must be terminated properly with one of four options. The DSA will detect and adjust to the termination option being used by a host.

The four options are:

- CR (ASCII 13)
- LF (ASCII 10)
- LF-CR (ASCII 10 - ASCII 13)
- CR-LF (ASCII 13 - ASCII 10)

The current DSA RS232 interface includes error checking. A checksum byte is generated and added to the end of the serial data packet. It is assumed that data will be transmitted in ASCII format. Data may be transmitted in BINARY format. If data are to be transmitted in BINARY format, then page mode transmission must be disabled.

Prior to version 1.08, the software would not attempt to output data if the sensor temperatures were less than 0 degrees C. Version 1.08 allows data output at temperatures below 0 °C. In this case, the EU conversion will use the last good set of coefficients. No errors will be logged. If this condition might exist, a user must monitor the sensor temperatures in the data output.

When a DSA module is in a “not ready” mode, all commands are disabled except STATUS and STOP. Examples of when the DSA module may be in a “not ready” state could be:

- During CALZ
- During SAVE
- While Scanning

COMMAND LIST**CALIBRATE**

Command	CALIBRATE
Command Syntax	CAL <press> [group]
Arguments	<p><press> - is a real number that represents the calibration pressure for this point.</p> <p>[group] - is a switch that determines the number of channels to calibrate. Group may be H, L or blank. L - Channels 0 - 7(ports 1-8)will be calibrated. H - Channels 8 - 15(ports 9-16) will be calibrated Blank - Channels 0 - 15(ports 1-16) will be calibrated.</p>
Description	<p>Commands the DSA to perform the following:</p> <ol style="list-style-type: none"> 1. Read one averaged frame of pressure and temperature counts. 2. Return calibration information for all channels calibrated in the following format: INSERT <temp> <chan> <press> <press counts>/M <p>NOTE: The DSA does not control the calibration. It will only read the information when commanded. The User must:</p> <ol style="list-style-type: none"> 1. Apply the control pressures to switch the calibration valves to the CAL mode. 2. Apply a known calibration pressure. 3. Issue the CAL command when the calibration pressure is stable.
Returns	<p>INSERT <temp><channel><press><press counts> M<nl></p> <p><temp> - the temperature plane <channels> - the channel in module-port notation <press> - the pressure in EU <press counts> - the A/D pressure counts(or bits) <nl> - end of line</p>
Example	<p>If a user wanted to calibrate ports 1 through 8 at 15 psi: Connect a pressure standard to the CAL input. Apply CTL1 and CTL2 Control pressures Enter the command: CAL 15 L<CR></p> <p>The DSA will measure the counts for each channel and return the appropriate INSERT commands.</p> <p>If a user wanted to calibrate all ports at 15 psi: Connect a pressure standard to the CAL input. Apply CTL1 and CTL2 Control pressures Enter the command: CAL 15<CR></p> <p>The DSA will measure the counts for each channel and return the appropriate INSERT commands.</p>

CALIBRATE BAROMETRIC PRESSURE

Command	CALIBRATE BAROMETRIC PRESSURE
Command Syntax	CALB <press> [period] [average]
Arguments	<p><press> - is a real number that represents the local barometric pressure.</p> <p>[period] - optional: sets the period for the CALB routine. If this value is not entered, the default period will be 300 microseconds.</p> <p>[average] - optional: sets the average for the CALB routine. If this value is not entered, the default average will be 64.</p>
Description	<p>Commands the DSA to perform the following:</p> <ol style="list-style-type: none"> 1. Read the current counts and enter them in the zero array (list z) 2. Lookup the counts for the pressure entered at the current temperature 3. Subtract the table counts from the zero counts and enter the difference in the delta array (list d) <p>NOTE: In order for the correction to be active, ZC must be set to 1.</p> <p>The CALB function only uses the entered pressure for channels that are defined as absolute sensors (ABS(x) = 1). If a channel is not defined as an absolute channel, the software will perform a CALZ on that channel.</p> <p>The pressure entered as the barometric pressure must be in the units defined in CVTUNIT (i.e.: PSI, kPa, etc)</p> <p>NOTE: The optional period may be the only optional parameter entered. If the optional average is entered, the optional period must be entered.</p>
Returns	<nl> - end of line
Example	<p>To correct all absolute sensors to read the local barometric pressure:</p> <p>Disconnect all inputs.</p> <p>Enter the command:</p> <p>CALB <press> (Where <press> is the local barometric pressure in the current engineering units.)</p> <p>If CVTUNIT is set to psi, and the local barometric pressure is 14.696 psia,, Enter the command: CALB 14.696</p> <p>If CVTUNIT is set to kPa, and the local barometric pressure is 101.3254, Enter the command: CALB 101.3254</p>

CALIBRATE ZERO

Command	CALIBRATE ZERO
Command Syntax	CALZ [period] [average] [delay]
Arguments	[period] - (optional) sets the period for the CALZ routine. If this value is not entered, the default period will be 300 microseconds. The value entered must be within the limits set for period. [average] - (optional) sets the average for the CALZ routine. If this value is not entered, the default average will be 64. The value entered must be within the limits set for average [delay] - (optional) sets the delay for the CALZ routine. If this value is not entered, the default delay will be 5 seconds. The limits are 5 to 60 seconds
Description	Commands the DSA to perform a quick zero calibration. This operation produces A/D count values for each pressure channel that is subtracted from the raw pressure counts before converting to the chosen pressure units. The data are stored in the ZERO(0-15) and DELTA(0-15) Configuration Variable Array. CALZ requires approximately 15 seconds to complete if the optional parameters are not entered. NOTE: To enter any of the optional parameters, the parameters in the string preceding it must also be entered. For example: To enter a value for average, a value for period must be entered, but not delay. To enter a value for delay, values for both period and average must also be entered.
Returns	<nl> <nl> - end of line
Example	To update the current ZERO file and correct for any zero drift of the transducers: Enter the command: CALZ The DSA will measure the zero counts for each channel and update the Zero and Delta Arrays. To update the current ZERO file and correct for any zero drift of the transducers using a period of 500 microseconds and an average of 32: Enter the command: CALZ 500 32 The DSA will measure the zero counts for each channel and update the Zero and Delta Arrays. To update the current ZERO file and correct for any zero drift of the transducers using a calz delay of 30 seconds and the nominal settings for period and average: Enter the command: CALZ 300 64 30 The DSA will measure the zero counts for each channel and update the Zero and Delta Arrays.

CLEAR

Command	CLEAR
Command Syntax	CLEAR
Arguments	None
Description	Commands the DSA to clear any errors that have occurred. The errors are sent to the client in an ASCII Packet. ASCII Packets are described in a subsequent sections.
Returns	<nl> <nl> - end of line.
Example	To clear any errors listed in the ERROR Buffer, the following command would be issued: CLEAR <CR> The ERROR buffer will be cleared

DELETE

Command	DELETE
Command Syntax	DELETE <start temp><end temp>[<channel>]
Arguments	<start temp> - an integer from 0 to 79 that represents the low point of the temperature planes to be deleted. <end temp> - an integer from 0 to 79 that represents the high point of the temperature planes to be deleted. <channel> - (optional) the channel to be deleted.
Description	Converts all pressure points within temperature planes between the low and high temperature range, inclusive, to "calculated". This allows new MASTER points to be entered via the CAL command. NOTE: See the description of the FILL command for more information.
Returns	<nl> <nl> - end of line.
Example	To delete the master points for all modules in a system using eight 32 channel modules, the following command would be issued: DELETE 0 79<CR> To delete the master points for channel 4, the following command would be issued: DELETE 0 79 4<CR> To delete the master points for channel 16, the following command would be issued: DELETE 0 79 16<CR>

ERROR

Command	ERROR
Command Syntax	ERROR
Arguments	None
Description	
Returns	The return format is: ERROR: error
Example	To read the contents of the Error Buffer: Type: ERROR<Enter> The DSA will return the last 30 errors in the format: ERROR: Port not found ERROR: List MI no group number ERROR: Group not between 1 and 8 If no errors have been logged, the DSA will return: ERROR: No errors

FILL

Command	FILL
Command Syntax	FILL
Arguments	None
Description	<p>Fills the Conversion Table with calculated pressure points and temperature planes using the MASTER calibrated points as guides. These “filled” points are marked as CALCULATED. The FILL command NEVER overwrites MASTER points. It does overwrite old points marked as CALCULATED.</p> <p>NOTE: The DELETE command must be used to change points marked as MASTER to CALCULATED before using the FILL command.</p>
Returns	<p><nl> <nl> - end of line.</p>
Example	<p>In this example, new MASTER points have been loaded and the coefficient table must be completed.</p> <p>Type: FILL<CR></p>

INSERT

Command	INSERT
Command Syntax	INSERT <temp> <chan> <press> <press counts> [M]
Arguments	<p><temp> - an integer from 0 to 79 that represents the temperature in degrees Celsius. <chan> - an integer from 0 to 15 identifying the channel. <press> - a real number that represents the calibration pressure point. <press counts> - a signed integer from 32767 to -32768 that represents the current pressure counts from the sensor. [M] - optional switch that designates the entry as a master conversion point.</p>
Description	<p>Inserts one pressure-pressure counts entry into the Conversion Table. If the M option is used this point is entered as a MASTER point. The LIST MASTER and LIST ALL commands download the contents of the conversion table in the format required by this INSERT command.</p>
Returns	<p><nl> <nl> - End of line.</p>
Example	<p>Although INSERT commands are most often entered from a Module Profile File, they may be entered from a keyboard.</p> <p>The following command will insert a master point at 30 °C for channel 1. The applied pressure is 11.9998 psi, the measured counts are 26376: INSERT 30 1 11.9998 26376 M</p> <p>The following command will insert a master point at 48 °C for channel 16. The applied pressure is 10.9998 psi, the measured counts are 20254: INSERT 48 16 10.9998 20254 M</p>

LIST ALL

Command	LIST ALL
Command Syntax	LIST A <Start Temp> <End Temp> [Channel]
Arguments	<Start Temp> - The lowest temp plane to be returned. <End Temp> - The highest temp plane to be returned. [Channel] - (Optional) may be 0 through 15.
Description	Lists all of the master and calculated points in the temperature-pressure correction matrix. The return format is: INSERT <temp> <chan> <press> <pressure counts> <M or C>
Returns	INSERT <temp> <channel> <press> <press counts> <M,C,I><nl> INSERT <temp> <channel> <press> <press counts> <M,C,I><nl> : : : : INSERT <temp> <channel> <press> <press counts> <M,C,I><nl> <temp> - the temperature plane <channel> - the channel in port notation <press> - the pressure in EU <press counts> - the A/D counts of pressure <nl> - end of line.
Example	To list all of the coefficients from 16 °C to 20 °C for channel 1 in a module calibrated from 17 °C to 40 °C type: LIST a 17 20 1<CR> The DSA will return a list of INSERT commands showing the temperature, channel, applied pressure, counts and the type of plane. INSERT 17 1 -45.949100 -26184 M INSERT 17 1 -31.250000 -17763 C INSERT 17 1 -19.969601 -11302 M INSERT 17 1 -6.250000 -3425 C INSERT 17 1 0.000000 162 M INSERT 17 1 19.984600 11636 M INSERT 17 1 25.000000 14523 C INSERT 17 1 35.000000 20281 C INSERT 17 1 45.949100 26586 M :: :: :: :: :: :: INSERT 20 1 -45.949100 -26166 C INSERT 20 1 -31.250000 -17750 C INSERT 20 1 -19.969601 -11292 C INSERT 20 1-1 -6.250000 -3424 C INSERT 20 1-1 0.000000 160 C INSERT 20 1-1 19.984600 11629 C INSERT 20 1-1 25.000000 14514 C INSERT 20 1-1 35.000000 20267 C INSERT 20 1-1 45.949100 26567 C

LIST ALL RANGES

Command	LIST ALL RANGES
Command Syntax	LIST B
Arguments	None
Description	Lists the 16 Absolute/Gauge Settings from the ABSn variable. NOTE: This is active only when MODEL is set to 3207.
Returns	<pre> SET ABS0 <1 or 0> SET ABS1 <1 or 0> SET ABS2 <1 or 0> SET ABS3 <1 or 0> SET ABS4 <1 or 0> SET ABS5 <1 or 0> SET ABS6 <1 or 0> SET ABS7 <1 or 0> SET ABS8 <1 or 0> SET ABS9 <1 or 0> SET ABS10 <1 or 0> SET ABS11 <1 or 0> SET ABS12 <1 or 0> SET ABS13 <1 or 0> SET ABS14 <1 or 0> SET ABS15 <1 or 0> </pre>
Example	<p>The DSA3207 could contain both Absolute and Gauge Transducers. The setting of ABSx defines the transducer type to the software. To display the transducer type defined for each channel in a DSA3207 with Absolute transducers installed in channels 1 - 6 and 13 - 16, and Gauge Transducers installed in channels 7 - 12, type: LIST B<CR></p> <p>The DSA module will return the following</p> <pre> SET ABS0 1 SET ABS1 1 SET ABS2 1 SET ABS3 1 SET ABS4 1 SET ABS5 1 SET ABS6 0 SET ABS7 0 SET ABS8 0 SET ABS9 0 SET ABS10 0 SET ABS11 0 SET ABS12 1 SET ABS13 1 SET ABS14 1 SET ABS15 1 </pre>

LIST CALIBRATE

Command	LIST CALIBRATE
Command Syntax	LIST C
Arguments	None
Description	Lists the CALIBRATION configuration variables.
Returns	SET PMAXL<press> SET PMAXH <press> SET PMINL <press> SET PMINH <press> SET NEGPTSL <num points> SET NEGPTSH <num points>
Example	To view the current conversion variable settings, type: LIST C<CR> The DSA will return the current conversion settings. They could appear as follows. SET PMAXL 18.09 SET PMAXH 18.09 SET PMINL -18.09 SET PMINH -18.09 SET NEGPTSL 4 SET NEGPTSH 4 SET ABS 0

LIST DELTA

Command	LIST DELTA
Command Syntax	LIST D
Arguments	None
Description	Lists the 16 delta zero correction values. These are used in the conversion of raw counts to Engineering Units(EU).
Returns	SET DELTA0 <delta> SET DELTA1 <delta> :: :: :: SET DELTA14 <delta> SET DELTA15 <delta>
Example	To view the current delta zero correction values, type: LIST D<CR> The DSA will return the delta zero correction values. They could appear as follows: SET DELTA0 0 SET DELTA1 1 SET DELTA2 0 SET DELTA3 1 :: :: :: SET DELTA12 1 SET DELTA13 0 SET DELTA14 1 SET DELTA15 0 NOTE: The delta values will vary as the module ages. These values are the difference between the current zero offset value obtained in the most recent CALZ and the zero value in the coefficient table.

DIGITAL OUTPUT

Command	DIGITAL OUTPUT
Command Syntax	DOUT <Number> <Value>
Arguments	<Number> - The digital output channel 0 through 5 <Value> - 1 = On 0 = Off
Description	Commands the DSA to energize or de-energize a Digital Output Channel.
Returns	<nl> <nl> - end of line.
Example	To energize Digital Output 1, type: DOUT 1 1<CR> To de-energize Digital Output 5, type: DOUT 5 0<CR>

LIST GAIN

Command	LIST GAIN
Command Syntax	LIST G
Arguments	None
Description	Lists the 16 temperature gains. These are used to convert temperature counts to degrees Celsius. This is the "M" term in the characterization equation: $^{\circ}\text{C} = \frac{\text{Counts} - \text{TempB}}{\text{TempM}}$
Returns	SET TEMPM0 <term> SET TEMPM1 <term> SET TEMPM2 <term> :: :: :: SET TEMPM13 <term> SET TEMPM14 <term> SET TEMPM15 <term>
Example	To view the temperature gain settings, type: LIST G<CR> The DSA will return the temperature gain settings. They could appear as follows. SET TEMPM0 793.000000 SET TEMPM1 432.000000 SET TEMPM2 441.000000 :: :: :: SET TEMPM13 412.000000 SET TEMPM14 422.000000 SET TEMPM15 432.000000 NOTE: The temperature gain settings are determined when the sensor is manufactured. They normally will not change after a calibration

LIST IDENTIFICATION

Command	LIST IDENTIFICATION
Command Syntax	LIST I
Arguments	None
Description	Lists the IDENTIFICATION configuration variables.
Returns	SET ECHO <term> SET MODEL <term> SET PORT <term> SET HOST <term>
Example	To verify the general module configuration settings of, type: LIST i<CR> The DSA3217 may return: SET ECHO 0 SET MODEL 3217 SET PORT 23 SET HOST 0.0.0.0 T NOTE: A user must be very careful when modifying one of these variables. An incorrect value in one of these variables could have a detrimental affect on the operation of the module.

LIST MASTER

Command	LIST MASTER
Command Syntax	LIST M <Start Temp> <End Temp> [Channel]
Arguments	<Start Temp> - The lowest temp plane to be returned. <End Temp> - The highest temp plane to be returned. [Channel] - (Optional) may be 0 through 15.
Description	Lists all of the MASTER POINTS in the temperature-pressure correction matrix. The return format is: INSERT <temp> <clear> <pressure> <pressure counts> M
Returns	INSERT <temp> <channel> <press> <press counts> M<nl> : : : : INSERT <temp> <channel> <press> <press counts> M<nl> <temp> - the temperature plane <channel> - The channel in module-port or serial number-port notation <press> - the pressure in EU <press counts> - the A/D counts of pressure <nl> - end of line
Example	To view the Master Points between 10 °C and 40 °C for channel 1 of the module, type: List m 10 40 1<CR> The DSA will return: INSERT 14 1 -5.958100 -21594 M INSERT 14 1 -4.476100 -15127 M INSERT 14 1 -2.994200 -8646 M INSERT 14 1 -1.470100 -1973 M INSERT 14 1 0.000000 4467 M INSERT 14 1 1.470100 10917 M INSERT 14 1 2.994200 17594 M INSERT 14 1 4.476100 24098 M INSERT 14 1 5.958100 30603 M INSERT 23 1 -5.958100 -21601 M INSERT 23 1 -4.476100 -15161 M INSERT 23 1 -2.994300 -8714 M INSERT 23 1 -1.470100 -2077 M INSERT 23 1 0.000000 4332 M INSERT 23 1 1.470100 10746 M INSERT 23 1 2.994200 17397 M INSERT 23 1 4.476100 23863 M INSERT 23 1 5.958100 30333 M INSERT 32 1 -5.958100 -21636 M INSERT 32 1 -4.476100 -15214 M INSERT 32 1 -2.994200 -8784 M INSERT 32 1 -1.470100 -2162 M INSERT 32 1 0.000000 4228 M INSERT 32 1 1.470100 10615 M INSERT 32 1 2.994200 17246 M INSERT 32 1 4.476100 23691 M INSERT 32 1 5.958100 30136 M

LIST MAXn PRESSURES

Command	LIST MAXn PRESSURES
Command Syntax	LIST H
Arguments	None
Description	Lists the 16 maximum pressures stored in the MAXn Variable. NOTE: This is active only when MODEL is set to 3207.
Returns	SET MAX0 <term> SET MAX1 <term> :: :: :: SET MAX14 <term> SET MAX15 <term>
Example	To view the maximum pressure settings for the module in the example of List Ranges type: LIST H<CR> The DSA will return the maximum pressure settings. They could appear as follows: SET MAX0 6.000000 SET MAX1 6.000000 :: :: :: SET MAX14 120.000000 SET MAX15 120.000000 NOTE: Generally, the maximum pressure setting is 20% greater than the full scale of the sensor to allow a user some over range indication.

LIST MINn PRESSURES

Command	LIST MAXn PRESSURES
Command Syntax	LIST L
Arguments	None
Description	Lists the 16 maximum pressures stored in the MINn Variable. NOTE: This is active only when MODEL is set to 3207.
Returns	SET MIN0 <term> SET MIN1 <term> :: :: :: SET MIN14 <term> SET MIN15 <term>
Example	To view the minimum pressure settings for the module in the example of List Ranges type: LIST L<CR> The DSA will return the minimum pressure settings. They could appear as follows: SET MIN0 -6.000000 SET MIN1 -6.000000 :: :: :: SET MIN13 -120.000000 SET MIN14 -120.000000 NOTE: Generally, the maximum pressure setting is 20% greater than the full scale of the sensor to allow a user some over range indication.

LIST NEGATIVE POINTS

Command	LIST NEGATIVE POINTS
Command Syntax	LIST N
Arguments	None
Description	Lists the Negative Points settings for each of the 16 channels in a DSA3207. NOTE: This is active only when MODEL is set to 3207.
Returns	<pre>SET NEGPTS0 <term> SET NEGPTS1 <term> SET NEGPTS2 <term> :: :: :: SET NEGPTS13 <term> SET NEGPTS14 <term> SET NEGPTS15 <term></pre>
Example	<p>To view the negative points set for the module in the example of List Ranges type: LIST L<CR></p> <p>The DSA will return the negative points settings. They could appear as follows.</p> <pre>SET NEGPTS0 4 SET NEGPTS1 4 SET NEGPTS2 4 :: :: :: SET NEGPTS13 4 SET NEGPTS14 4 SET NEGPTS15 4</pre>

LIST OFFSET

Command	LIST OFFSET
Command Syntax	LIST O
Arguments	None
Description	<p>Lists the 16 temperature offsets. These are used in the conversion of temperature counts to degrees Celsius. This is the "B" term in the correction equation:</p> $^{\circ}\text{C} = \frac{\text{Counts} - \text{TempB}}{\text{TempM}}$
Returns	<pre>SET TEMPB0 <term> SET TEMPB1 <term> :: :: :: SET TEMPB14 <term> SET TEMPB15 <term></pre>
Example	<p>To view the temperature offset settings. type: LIST O<CR></p> <p>The DSA will return the temperature offset settings. They could appear as follows.</p> <pre>SET TEMPB0 -14121. SET TEMPB1 -10631. :: :: :: SET TEMPB14 -6328. SET TEMPB15 -6156.</pre> <p>NOTE: The temperature offset settings are determined when the sensor is manufactured. They normally will not change after a calibration</p>

LIST SCAN

Command	LIST SCAN
Command Syntax	LIST S
Arguments	None
Description	Lists the SCAN configuration variables
Example	<p>This command is used to verify the general scan settings of the DSA, type: LIST S<CR></p> <p>The DSA will return:</p> <pre> SET PERIOD 200 SET AVG 32 SET FPS 1 SET XSCANTRIG 0 SET FORMAT 0 SET TIME 0 SET EU 1 SET ZC 1 SET BIN 0 SET SIM 0 SET QPKTS 0 SET UNITSCAN PSI SET CVTUNIT 1.000000 SET PAGE 0 </pre>

LIST ZERO

Command	LIST ZERO
Command Syntax	LIST Z
Arguments	None
Description	Lists the 16 zero correction values. These are used in the conversion of raw counts to zero corrected counts.
Example	<p>To view the current zero correction values, type: LIST Z<CR></p> <p>The DSA will return the zero correction values. They could appear as follows.</p> <pre> SET ZERO0 261 SET ZERO1 -86 SET ZERO2 -49 SET ZERO3 -6 SET ZERO4 -20 SET ZERO5 47 SET ZERO6 44 SET ZERO7 23 SET ZERO8 -51 SET ZERO9 47 SET ZERO10 6 SET ZERO11 26 SET ZERO12 53 SET ZERO13 37 SET ZERO14 -57 SET ZERO15 -20 </pre> <p>NOTE: The zero values will be updated after a CALZ.</p>

SAVE

Command	SAVE
Command Syntax	SAVE
Arguments	None
Description	Commands the DSA to save the RAM image of the Non Volatile Memory. Any change to a configuration variable must be followed by a SAVE command if the change is to be permanent.
Returns	<nl> <nl> - End of line.
Example	To save the current configuration variable settings and conversion coefficients, Type: SAVE<CR>

SCAN

Command	SCAN
Command Syntax	SCAN
Arguments	None
Description	Commands the DSA to scan the pressure sensors and send Scan packets to the client.
Example	<p>A scan command is executed with EU set to 1, BIN set to 0, and FORMAT set to 0. Data are scrolled and will be displayed as follows:</p> <pre> Frame # <number> Time <time> <μs or ms> <chan> <press eu> <temp eu> " " " " " " <chan> <press eu> <temp eu> </pre> <p>A scan command is executed with EU set to 0, BIN set to 0, and FORMAT set to 0. Data are scrolled and will be displayed as follows:</p> <pre> Frame # <number> Time <time> <μs or ms> <chan> <press counts> <temp counts> " " " " " " <chan> <press counts> <temp counts> </pre> <p>A scan command is executed with EU set to 1, BIN set to 0, and FORMAT set to 1. Data are scrolled and will be displayed as follows:</p> <pre> Frame = <number> Time = <time> <μs or ms> <chan> <press eu> <chan><press eu> <chan> <press eu> <chan> <press eu> <chan> <press eu> <chan><press eu> <chan> <press eu> <chan> <press eu> <chan> <press eu> <chan><press eu> <chan> <press eu> <chan> <press eu> <chan> <press eu> <chan><press eu> <chan> <press eu> <chan> <press eu> </pre> <p>A scan command is executed with EU set to 0, BIN set to 0, and FORMAT set to 1. Data are scrolled and will be displayed as follows:</p> <pre> Frame = <number> Time = <time> <μs or ms> <chan> <press cts> <chan><press cts> <chan> <press cts> <chan> <press cts> <chan> <press cts> <chan><press cts> <chan> <press cts> <chan> <press cts> <chan> <press cts> <chan><press cts> <chan> <press cts> <chan> <press cts> <chan> <press cts> <chan><press cts> <chan> <press cts> <chan> <press cts> </pre>

SCAN TRIGGER

Command	SCAN TRIGGER
Command Syntax	TRIG or <tab>
Arguments	None
Description	This command acts as a software trigger to the DSA. When XSCANTRIG is set to 1, an averaged frame of data will be output when the DSA receives the TRIG command or a <TAB> character code (9 HEX or Control I). This will continue until a STOP command is issued or the Frames Per Scan (FPS) variable is met. The data format will depend upon the setting of EU, BIN and FORMAT.
Example	A scan command is executed with EU set to 1, BIN set to 0, XSCANTRIG set to 1, and FORMAT set to 0. The DSA will wait for a Hardware trigger, the TRIG command or a <TAB> character (9 HEX or Control I). When one of the Data are scrolled and will be displayed as follows: <pre> Frame # <number> Time <time> <µs or ms> <chan> <temp eu> " " " " <chan> <temp eu> </pre> For information on other formats, refer to the SCAN command .

SET

Command	SET
Command Syntax	SET <name> <value>
Arguments	<name> - the Configuration Variable to be set or modified. <value> - the value of that Configuration Variable
Description	Commands the DSA to set one of the many Configuration Variables. Configuration Variables are described in a subsequent section. NOTE: Listing the Configuration Variables with the LIST command outputs the data in the format required by the SET command. This enables the user to upload data from a file that has been created by a LIST download.
Returns	<nl> <nl> - End of line.
Example	To change the variable Frames Per Scan (FPS) from 10 to 5, type: SET FPS 5 <CR> To change the variable Time (TIME) from off (0) to on (1), type: SET TIME 1 <CR>

STATUS

Command	STATUS
Command Syntax	STATUS
Arguments	None
Description	Commands the DSA to send a Status Packet to the client. The Status Packet is described in a subsequent section. The STATUS command may be entered at any time. This is one of the commands that will not generate an error if entered while the DSA is not READY.
Returns	One of the following: STATUS: READY STATUS: CALZ STATUS: SAVE
Example	If the STATUS command is entered while the DSA is on, but inactive, the DSA will return: STATUS: READY If the STATUS command is entered while the DSA is executing a Calibrate Zero command, the DSA will return: STATUS CALZ

STOP

Command	STOP
Command Syntax	STOP or <esc>
Arguments	None
Description	Commands the DSA to abort the current operation.
Returns	<nl> <nl> - end of line.
Example	To abort any function or operation, type: STOP<CR>

UPLOAD

Command	UPLOAD
Command Syntax	UPLOAD <S or C><filepath\filename>
Arguments	S - System file to be uploaded C - Configuration file to be uploaded
Description	Uploads the specified file to the DSA module. The DSA interprets the type of file based on the file type argument.
Returns	<nl> <nl> - end of line.
Example	To upload the configuration variable file <u>cv.cfg</u> , located in the dsafiles subdirectory on drive c: of the host computer, type: UPLOAD C c:\dsafiles\cv.cfg NOTE: S or C must be uppercase. Refer to "DSA3200 Operating System Upload" on page 60 for more information.

VERSION

Command	VERSION
Command Syntax	VER
Arguments	None
Description	Outputs the current software version number.
Returns	VERSION: DsaHs Scanivalve © 2000 -2013 Ver <ver number>
Example	To read the current software version, type: VER<CR> The DSA returns: VERSION: DsaHs Scanivalve © 2000 - 2013 Ver 1.17

CONFIGURATION VARIABLES

Configuration Variables control the way the DSA functions. The variables are assigned to one of several groups: SCAN (LIST S), CALIBRATION (LIST B, LIST C, LIST H, LIST L, LIST N), IDENTIFICATION (LIST I) or PRESSURE (LIST D, LIST O, LIST G, and LIST Z). Each variable is assigned a “data type” description.

SCAN VARIABLES (LIST S)**AVERAGE (AVG)**

Variable	AVG
Valid Values	1 to 240
Default Value	16
Data Type	integer
Group	Scan variables (List S)
Description	This sets the number of raw samples to acquire before producing a averaged output.

BINARY DATA (BIN)

Variable	BIN
Valid Values	0 or 1
Default Value	1
Data Type	integer
Group	Scan variables (List S)
Description	Sets the format of the data packet output. 1 = Binary 0 = ASCII

UNIT CONVERSION FACTOR (CVTUNIT)

Variable	CVTUNIT
Valid Values	any real number
Default Value	1.0
Data Type	float
Group	Scan variables (List S)
Description	Unit conversion factor. This converts the calibrated units to the requested scan units. This value can be set directly or by setting the UNITSCAN variable to the desired unit. CVTUNIT will be set whenever UNITSCAN is set. It may be set independently without setting UNITSCAN. If a user wants to have CVTUNIT set to a different variable from UNITSCAN, UNITSCAN must be set first.

ENGINEERING UNITS (EU)

Variable	EU
Valid Values	0 or 1
Default Value	1
Data Type	string
Group	Scan variables (List S)
Description	<p>Sets the output format for temperature and pressure units.</p> <p>0 = raw units 1 = Engineering units</p> <p>NOTE: The module will output 999999 when one or more of the following conditions exist:</p> <ol style="list-style-type: none"> 1. The EU conversion exceeds the setting of PMAXL or PMAXH 2. The calculated temperature of any sensor is greater than 69 degrees C. <p>The module will output -999999 when one or more of the following conditions exist:</p> <ol style="list-style-type: none"> 1. The EU conversion exceeds the setting of PMINL or PMINH 2. The calculated temperature of any sensor is greater than 69 degrees C.

DATA FORMAT (FORMAT)

Variable	FORMAT
Valid Values	0 or 1
Default Value	0
Data Type	integer
Group	Scan variables (List S)
Description	<p>Determines if data are to be scrolled on the display. ASCII Output only</p> <p>0 - data are scrolled 1 - data are displayed in place, formatted for a VT100 terminal.</p>

FRAMES PER SCAN (FPS)

Variable	FPS
Valid Values	0 to 2147483648
Default Value	100
Data Type	long integer
Group	Scan variables (List S)
Description	<p>Frames Per Scan (FPS) sets the number of averaged frames to send to the host computer when a scan command is issued. Averaged frames will be sent to the host computer until the value of FPS is met. At that time the DSA will exit the scan mode and wait for another command. If a 0 is entered, the scan will continue until a STOP command is received.</p>

PAGE (PAGE)

Variable	PAGE
Valid Values	0 or 1
Default Value	0
Data Type	integer
Group	Scan variables (List S)
Description	<p>When set to 1, the DSA will accumulate 10 frames of data before the data is sent over the network. If FPS is set to a number less than 10, the data will be sent over the network when FPS is completed. When a STOP command is issued, the frame acquisition will stop on a 10 frame boundary.</p> <p>NOTE: This variable is active in UDP mode only.</p>

PERIOD (PERIOD)

Variable	PERIOD
Valid Values	125 to 65535
Default Value	500
Data Type	integer
Group	Scan variables (List S)
Description	<p>Sets the interval between channel samples. Period is related to the scan rate, or frequency by the formula: $\text{Data Rate} = 1 \div (\text{Period} \times 16 \times \text{Average})$</p>

QPKTS

Variable	QPKTS
Valid Values	0 or 1
Default Value	0
Data Type	integer
Group	Scan variables (List S)
Description	<p>This switch will control the action the DSA will take when the data buffer is full.</p> <p>0 - frames will be discarded when the data buffer is full. The DSA will continue to scan.</p> <p>1 - no frames will be lost. The DSA will stop scanning and log an error if the data buffer is filled.</p>

DATA SAMPLE SOURCE (SIM)

Variable	SIM
Valid Values	0 or 1
Default Value	1
Data Type	integer
Group	Scan variables (List S)
Description	<p>Determines the source of the data samples.</p> <p>0 - Data are taken from the sensors</p> <p>1 - Data are generated internally</p>

TIME STAMP (TIME)

Variable	TIME
Valid Values	0, 1 or 2
Default Value	0
Data Type	integer
Group	Scan variables (List S)
Description	Determines the format of the Time Stamp. 0 - No Time Stamp 1 - Time stamp data are in microseconds 2 - Time stamp data are in milliseconds

SCAN UNIT (UNITSCAN)

Variable	UNITSCAN																														
Valid Values	See list in description																														
Default Value	PSI																														
Data Type	string																														
Group	Scan variables (List S)																														
Description	Unit scan factor. This sets the scan units for the DSA. Setting this value will also set CVTUNITS. CVTUNITS may be set to a different value, however UNITSCAN must be set first. The following are the list of units supported <table border="0" style="width: 100%; border-collapse: collapse;"> <tr> <td>ATM</td> <td>FTH2O</td> <td>KGM2</td> <td>MH2O</td> <td>OZFT2</td> </tr> <tr> <td>BAR</td> <td>GCM2</td> <td>KIPIN2</td> <td>MMHG</td> <td>OZIN2</td> </tr> <tr> <td>CMHG</td> <td>INHG</td> <td>KNM2</td> <td>MPA</td> <td>PA</td> </tr> <tr> <td>CMH2O</td> <td>INH2O</td> <td>KPA</td> <td>NCM2</td> <td>PSF</td> </tr> <tr> <td>DECIBAR</td> <td>KGCM2</td> <td>MBAR</td> <td>NM2</td> <td>PSI</td> </tr> <tr> <td>TORR</td> <td></td> <td></td> <td></td> <td></td> </tr> </table> If a value other than those listed is entered, PSI will be used. It is best to use uppercase when entering these units.	ATM	FTH2O	KGM2	MH2O	OZFT2	BAR	GCM2	KIPIN2	MMHG	OZIN2	CMHG	INHG	KNM2	MPA	PA	CMH2O	INH2O	KPA	NCM2	PSF	DECIBAR	KGCM2	MBAR	NM2	PSI	TORR				
ATM	FTH2O	KGM2	MH2O	OZFT2																											
BAR	GCM2	KIPIN2	MMHG	OZIN2																											
CMHG	INHG	KNM2	MPA	PA																											
CMH2O	INH2O	KPA	NCM2	PSF																											
DECIBAR	KGCM2	MBAR	NM2	PSI																											
TORR																															

ENABLE EXTERNAL TRIGGER (XSCANTRIG)

Variable	XSCANTRIG
Valid Values	0 or 1
Default Value	0
Data Type	integer
Group	Scan variables (List S)
Description	Sets the External Trigger as the Frame Trigger. 0 - the internal clock is the frame trigger 1 - the external trigger is the frame trigger

ZERO CORRECTION (ZC)

Variable	ZC
Valid Values	0 or 1
Default Value	1
Data Type	integer
Group	Scan variables (List S)
Description	<p>Sets zero correction on or off. 0 - no correction 1 - zero correction</p> <p>NOTE 1: ZC must be set to 0 for the following conditions: 1. Model is set to 3207 2. The module has gauge transducers installed.</p> <p>NOTE 2: ZC must be set to 0 for the following conditions: 1. Model is set to 3207 2. Absolute sensors are installed and the CALB command will not be used.</p> <p>NOTE 3: ZC must be set to 1 for the following conditions: 1. Model is set to 3217 or 3218 2. Differential transducers are installed</p> <p>NOTE 4: ZC must be set to 1 for the following conditions: 1. Model is set to 3207 2. Absolute sensors are installed and the CALB command will be used.</p>

PRESSURE VARIABLES (LIST B, LIST H, LIST L AND LIST N)

ABSOLUTE ENABLE (ABS_N)

Variable	ABS _n (where n = 0-15 for channels 1-16)
Valid Values	0 or 1
Default Value	determined by module type
Data Type	integer
Group	Calibration variables (List B)
Description	Sets the mode of operation of the module. NOTE: This is active only when MODEL is set to 3207. 0 = gauge or differential 1 = absolute

MAXIMUM PRESSURE (MAX_N)

Variable	MAX _n (where n = 0-15 for channels 1-16)
Valid Values	0 through 500
Default Value	15
Data Type	integer
Group	Calibration variables (List H)
Description	Sets the maximum pressure for channel n. This variable is only used if MODEL is set to 3207. This must be set to zero or to a positive number if the module is an absolute module.

MINIMUM PRESSURE (MIN_N)

Variable	MIN _n (where n = 0-15 for channels 1-16)
Valid Values	0 through 500
Default Value	0
Data Type	integer
Group	Calibration variables (List L)
Description	Sets the maximum pressure for channel n. This variable is only used if MODEL is set to 3207. This must be set to zero or to a positive number if the module is an absolute module.

NEGATIVE CALIBRATION POINTS (NEGPTS_N)

Variable	NEGPTS _n (where n = 0-15 for channels 1-16)
Valid Values	0 to 8
Default Value	4
Data Type	integer
Group	Calibration variables (List N)
Description	Sets the number of negative calibration points for channel n. This must be set to zero or to a positive number if the module is an absolute module. This variable is only used if MODEL is set to 3207.

CALIBRATION VARIABLES (LIST C)***CHANNEL 1-8 NUMBER OF NEGATIVE CALIBRATION POINTS (NEGPTSL)***

Variable	NEGPTSL
Valid Values	0 through 8
Default Value	4
Data Type	integer
Group	Calibration variables (List C)
Description	Sets the number of negative calibration points for channels 1 - 8. This must be set to zero or to a positive number if the module is an absolute module.

CHANNEL 9-16 NUMBER OF NEGATIVE CALIBRATION POINTS (NEGTPSH)

Variable	NEGTPSH
Valid Values	0 through 8
Default Value	4
Data Type	integer
Group	Calibration Variables (List C)
Description	Sets the number of negative calibration points for channels 9 - 16. This must be set to zero or to a positive number if the module is an absolute module.

CHANNEL 1-8 MAXIMUM PRESSURE (PMAXL)

Variable	PMAXL
Valid Values	any real number
Default Value	determined by module type
Data Type	float
Group	Calibration variables (List C)
Description	Sets the maximum pressure for channels 1 - 8. NOTE: The module will output 999999 if the measured pressure exceeds this value.

CHANNEL 9-16 MAXIMUM PRESSURE (PMAXH)

Variable	PMAXH
Valid Values	any real number
Default Value	determined by module type
Data Type	float
Group	Calibration variables (List C)
Description	Sets the maximum pressure for channels 9 - 16. NOTE: The module will output 999999 if the measured pressure exceeds this value.

CHANNEL 1-8 MINIMUM PRESSURE (PMINL)

Variable	PMINL
Valid Values	any real number
Default Value	determined by module type
Data Type	float
Group	Calibration Variables (List C)
Description	Sets the minimum pressure for channels 1 - 8. This must be set to zero or to a positive number if the module is an absolute module. NOTE: The module will output -999999 if the measured pressure exceeds this value.

CHANNEL 9-16 MINIMUM PRESSURE (PMINH)

Variable	PMINH
Valid Values	any real number
Default Value	determined by module type
Data Type	float
Group	Calibration Variables (List C)
Description	Sets the minimum pressure for channels 9 -16. This must be set to zero or to a positive number if the module is an absolute module. NOTE: The module will output -999999 if the measured pressure exceeds this value.

IDENTIFICATION VARIABLES (LIST I)***SERIAL ECHO (ECHO)***

Variable	ECHO
Valid Values	0 or 1
Default Value	0
Data Type	integer
Group	Identification variables (List I)
Description	Determines if characters received from a serial host will be echoed back to the host. 0 - the DSA will not echo characters 1 - the DSA will echo characters back to the host

MODEL (MODEL)

Variable	MODEL
Valid Values	3207, 3217, 3218
Default Value	3217
Data Type	string
Group	Identification variables (List I)
Description	Determines the module type. When set to 3207, special variables are enabled to permit up to eight(8) ranges in a module. The recommended setting of ZC depends on the setting of MODEL. Please refer to the description of ZC for more information. NOTE: MODEL must be set to 3207 in a 3217 or 3218 with absolute sensors installed if the CALB function will be used.

ETHERNET PORT (PORT)

Variable	PORT
Valid Values	any valid port other than 0
Default Value	23
Data Type	integer
Group	Identification variables (List I)
Description	Sets the Ethernet port. The default value is 23 which is the TelNet port. A change to this variable does not take effect until the module has been rebooted. If PORT is set to zero, communications in Ethernet will be impossible.

ETHERNET HOST (HOST)

Variable	HOST <IP Address> <Port> <Protocol>
Valid Values	IP Address - Any valid IP Address Port - Any valid port number other than 0 Protocol - U for UDP T for TCP
Default Value	IP Address - 0 Port - 0 Protocol - T
Data Type	varies
Group	Identification variables (List I)
Description	Sets the parameters for binary transmission to a host computer. The default port value is 23 which is the TelNet port. A change to this variable does not take effect until the module has been rebooted. If PORT is set to zero, communications in Ethernet will be impossible.

PRESSURE DELTAS (LIST D)

DELTAS (DELTAN)

Variable	DELTAn (where n = 0-15 for channels 1-16)
Valid Values	-32768 to 23768
Default Value	none
Data Type	integer
Group	Pressure variables (List D)
Description	Delta zero corrections for channels 1 - 16. These values are set when a CALZ is executed.

TEMPERATURE OFFSETS (LIST O)

TEMPERATURE OFFSET (TEMPBN)

Variable	TEMPBn (where n = 0-15 for channels 1-16)
Valid Values	any real number
Default Value	none
Data Type	float
Group	Pressure variables (List O)
Description	The "B" term in the conversion equation used to convert temperature counts to degrees Celsius. The conversion formula is: $^{\circ}\text{C} = \frac{\text{Counts} - \text{TempB}}{\text{TempM}}$

TEMPERATURE GAINS (LIST G)**TEMPERATURE GAIN (TEMPMn)**

Variable	TEMPMn (where n = 0-15 for channels 1-16)
Valid Values	any real number
Default Value	none
Data Type	float
Group	Pressure variables (List G)
Description	The "M" term in the conversion equation used to convert temperature counts to degrees Celsius. The conversion formula is: $^{\circ}\text{C} = \frac{\text{Counts} - \text{TempB}}{\text{TempM}}$

ZERO OFFSETS (LIST Z)**ZERO OFFSET (ZEROn)**

Variable	ZEROn (where n = 0-15 for channels 1-16)
Valid Values	-32768 to 32768
Default Value	none
Data Type	integer
Group	Pressure variables (List Z)
Description	The zero correction for channels 0 - 15. These values are set during the original calibration and fill.

DSA PACKET DEFINITIONS

When requested the DSA sends an application packet to the client. Each packet sent to the client starts with a Packet Type Word. This word defines the packet type.

PACKET TYPES

Packet Name	Packet ID	Bytes	Notes
Scan	1Hex	304	Binary scan packet (NOT USED)
Status	3Hex	180	Long status packet
Scan Raw	4Hex	72	Transmits pressure and temperature data in binary, raw counts
Scan EU	5Hex	104	Transmits pressure and temperature data in binary, engineering units
Scan Raw - Time	6Hex	80	Transmits pressure data in binary, raw counts with a time stamp
Scan EU - Time	7Hex	112	Transmits pressure data in binary, engineering units with a time stamp
ASCII	20Hex	Variable	Text packet may be formatted or un-formatted. The format is determined by the setting of FORMAT configuration variable. NOTE: When the first integer of the packet is 20Hex or greater, the packet is assumed to be in ASCII format.

HOST TO DSA COMMAND PACKET

Function Description	Bytes	Data Type	Values
ASCII command data (refer to the command section of this manual for more information)	1 to 512	String	Unique to packet. Each line must be terminated with a <CR>, <LR>, <CR-LF> or <LF-CR>

DSA TO HOST SCAN PACKET (NOT USED)

Function Description	Bytes	Data Type	Value/Notes
Packet Type	2	Integer	1Hex
Pad Bytes (forces quad byte alignment)	2	Integer	undefined
Module Name	20	char[20]	(note used) (note used)
Channels 1 through 8 - Minimum Pressure	4	Float	(note used)
Channels 9 through 16 - Minimum Pressure	4	Float	(note used)
Channels 1 through 8 - Maximum Pressure	4	Float	(note used)
Channels 9 through 16 - Maximum Pressure	4	char[12]	Type of Scan
Pressure Type	12	char[12]	Scan Units
Pressure Units	12	char[12]	Temperature Units
Temperature Type	12	char[12]	Current DSA Status
Status	20	char[20]	Current DSA Errors
Error	60	char[60]	
Periodo	2	Integer	
Skip Frames	2	Integer	
Average	2	Integer	
Year	2	Integer	
Month	2	Integer	
Day	2	Integer	
Hour	2	Integer	
Minute	2	Integer	
Second	2	Integer	
Millisecond	2	Integer	
Channels 1-16 Pressures	64	Float	4 bytes per channel
Channels 1-16 Temperatures	64	Integer	°C, 4 bytes per channel

STATUS PACKET

Function Description	Bytes	Data Type	Value/Notes
Packet Type	2	Integer	3Hex
Pad bytes (forces quad byte alignment)	78	Integer	unidentified
Status	20	char[20]	Current DSA Status
Pad bytes (forces quad byte alignment)	80	Integer	(not used)

SCAN RAW PACKET

Function Description	Bytes	Data Type	Value/Notes
Packet Type	2	Integer	4Hex
Pad bytes (forces quad byte alignment)	2	Integer	unidentified
Frame Number	4	Integer	Current Frame Number
Channels 1-16 Pressure	32	Integer	2 bytes per channel
Channels 1-16 Temperature	32	Integer	2 bytes per channel

SCAN EU PACKET

Function Description	Bytes	Data Type	Value/Notes
Packet Type	2	Integer	5Hex
Pad bytes (forces quad byte alignment)	2	Integer	unidentified
Frame Number	4	Integer	Current Frame Number
Channels 1-16 Pressure	64	Float	4 bytes per channel
Channels 1-16 Temperature	32	Integer	°C, 2 bytes per channel

SCAN RAW WITH TIME PACKET

Function Description	Bytes	Data Type	Value/Notes
Packet Type	2	Integer	6Hex
Pad bytes (forces quad byte alignment)	2	Integer	unidentified
Frame Number	4	Integer	Current Frame Number
Channels 1-16 Pressure	32	Integer	2 bytes per channel
Channels 1-16 Temperature	32	Integer	2 bytes per channel
Time in milliseconds or microseconds	4	Integer	2 bytes
Time Units	4	Integer	1 = microseconds 2 = milliseconds

SCAN EU WITH TIME PACKET

Function Description	Bytes	Data Type	Value/Notes
Packet Type	2	Integer	7Hex
Pad bytes (forces quad byte alignment)	2	Integer	unidentified
Frame Number	4	Integer	Current Frame Number
Channels 1-16 Pressure	64	Float	4 bytes per channel
Channels 1-16 Temperature	32	Integer	°C, 2 bytes per channel
Time in milliseconds or microseconds	4	Integer	2 bytes
Time Units	4	Integer	1 = microseconds 2 = milliseconds

ASCII PACKET

Function Description	Bytes	Data Type	Value/Notes
ASCII data (the first two bytes must NOT be 1Hex through 1FHex). Refer to the Command Section of this manual for the proper Command return formats.	1 to 1492	String	Unique to packet. Each line must be terminated with a <CR>, <LR>, <CR-LF> or <LF-CR>

This packet will be transmitted when the host issues one of the following commands:

1. SCAN with BIN set to 0
2. LIST n
3. ERROR
4. STATUS

ASCII PACKET EXAMPLES

The following shows the format of the ASCII DATA portion of the List Packet in response to a LIST MASTER (LIST M):

```
INSERT <temp> <chan> <press> <press counts> /M
INSERT <temp> <chan> <press> <press counts> /M
      :       :       :       :
INSERT <temp> <chan> <press> <press counts> /M
```

When a LIST ALL is commanded, Master and Calculated planes are listed. The Master items will have a /M suffix while the Calculated items will have a /C. The following is an example of a LIST ALL (LIST A) command:

```
INSERT <temp> <chan> <press> <press counts>/M
INSERT <temp> <chan> <press> <press counts>/C
      :       :       :       :
INSERT <temp> <chan> <press> <press counts>/M
```

For examples of the ASCII Packets returned from a SCAN command, refer to the SCAN command.

NETWORK PROTOCOLS SUPPORTED

Physical Layer : 10Base-T IEEE 802.3

Link Layer: INTERNET Protocol (IP)

Transport Layer: Transmission Control Protocol (TCP)
User Datagram Protocol (UDP)

DSA3200 BOOT PARAMETERS

To view the DSA3200 module's boot parameters:

1. De-energize the DSA3200. Connect the DSA3200 trigger/serial test cable (Scanco part #155829) from the DSA3200 to a host PC.
2. Start HyperTerminal, or an equivalent communication program. Connect the DSA3200 to a COM port on the PC Host. Set the serial parameters to 9600 BAUD, no parity, 8 data bits and 1 stop bit.
3. Energize the DSA3200. The following sign-on information should be displayed.

```
VxWorks System Boot
Copyright 1984-1997 Wind River Systems, Inc.
CPU: HITACHI hs7709
Version: 5.3.1
BSP version: 1.1/0
Creation date: Feb 9 2000, 12:41:05
Scanivalve (c)2000, Boot loader version 1.00
Press any key to stop auto-boot...
```
4. Press any key within 3 seconds to stop the auto-boot process. If a key is not pressed within the 3 seconds time, the system will proceed to auto-boot with the existing operating system using the current setup.

NOTE: The boot-loader will continue to reboot until stopped by pressing a key under the following conditions:

- If boot-from-flash is selected, and no operating system is present in flash.
- If boot-from-net is selected and the FTP server is not correctly set up.

5. When the auto-boot process is stopped, the boot-loader will prompt with:
[VxWorks Boot]:

To get a list of the existing boot parameters:

```
Type:    p <Enter>
```

The following list is a sample of the default setup:

```
boot device           :cs
processor number      :0
host name             :host
file name             :c:/dsa_hs/vxworks.st
inet on ethernet (e) : 91.30.80.100
host inet (h)        :191.30.101.109
user (u)              :DSA_HS
ftp password (pw)    :scanivalve
flags (f)            :0x0
other (o)            :flash,000.096.093.218.0
                    00.002,10baset
```

The functions of the boot parameters are as follows:

boot device: Must not be changed from cs
 processor number: Must not be changed from 0
 host name: Must not be changed from host.
 file name: The full path name of the operating system file name to be booted from, when booting from the network. The default path and file in this line is the path and file used at Scanivalve.
 inet on ethernet(e): The internet address of this DSA3200. The subnet mask may be specified when entering this parameter by entering a colon followed by the subnet mask in hex notation. I.e. 191.30.85.100:FFFFFF00
 inet on backplane (b): Must be left blank
 host inet (h): The internet address of the host to boot from.

gateway inet (g): The internet address of a gateway node if the host is not on the same network as the DSA3200.
 user (u): The user name that the DSA3200 uses to access the host. This is the name that must be set up in the FTP server on the host. The FTP server must be set up to provide that user name with the proper permission to read from the host directory and the password must be set correctly.
 ftp password (pw): The user password. This must be supplied to boot from host. Must be 0x0
 flags (f): Must be blank
 target name (tn): Must be blank
 startup script (s): Must be blank
 other (o): This specifies the place to boot from, the MAC address, and the network media. The line must not contain any spaces and each parameter is separated by a comma. The syntax is:
 <bootloc>,<mac address>,<media type>
 Valid values are case sensitive and are as follows:
 <bootloc>
 net - Boot from network
 flash - Boot from flash
 <mac address>
ddd.ddd.ddd.ddd.ddd.ddd
 <media type>
 10base2 - 10Base2 type
 10baset - 10BaseT type

CHANGING BOOT PARAMETERS (INCLUDING IP ADDRESS)

The DSA3200 Series modules use an operating system licensed from VxWorks. The boot parameters are set at the factory, but these parameters may be modified to suit the needs of a specific installation. To change any of the boot parameters:



CAUTION! Do NOT change the boot device, processor number, host name, inet on backplane, flags, target name, startup script or other boot parameters.

1. De-energize the DSA3200. Connect the DSA3200 trigger/serial test cable (Scanco part #155829) from the DSA3200 to a host PC.
2. Start HyperTerminal, or an equivalent communication program. Connect the DSA3200 to a COM port on the PC Host. Set the serial parameters to 9600 BAUD, no parity, 8 data bits and 1 stop bit, no flow control.
3. Energize the DSA3200. The following sign-on information should be displayed.

```
VxWorks System Boot
Copyright 1984-1997 Wind River Systems, Inc.
CPU: HITACHI hs7709
Version: 5.3.1
BSP version: 1.1/0
Creation date: Feb 9 2000, 12:41:05
Scanivalve (c)2000, Boot loader version 1.00
Press any key to stop auto-boot...
```
4. Press any key within 3 seconds to stop the auto-boot process. If a key is not pressed within the 3 seconds time, the system will proceed to auto-boot with the existing operating system using the current setup.
5. When the auto-boot process is stopped, the boot-loader will prompt with:

```
[VxWorks Boot]:
```

 To get a list of the existing boot parameters:

```
Type: p <Enter>
```

 To change any of the boot parameters:

```
Type: c <Enter>
```
6. Press <Enter> to cycle through the list of boot parameters. If a particular field has the correct value and does not need to be changed, Press: <Enter>. To change the value of a boot parameter, simply type the new value in left of the existing value.

NOTE: If any other key is pressed, that will replace the existing information. This includes the space and backspace keys.

 To clear a field,

```
Type: . <Enter>
```

 To quit before viewing all of the parameters,

```
Type: CTRL+D.
```
7. After all changes have been made, and the [VxWorks Boot]: prompt returns, verify the new settings:

```
Type: p <Enter>
```

 The settings are saved in flash at this point.
8. To restart operating system, with the new settings,

```
Type: @ <Enter>
```

 (This is the "Load and Go" command.)

-or-

 Cycle the power to the module.
9. If the DSA3200 boots correctly, de-energize the DSA3200 and disconnect the serial test cable.
10. Re-apply power to the DSA3200.

DSA3200 BUFFER DESCRIPTION

The DSA3200 buffer is a software buffer. It is set up as a FIFO. It is factory set to hold 10000 averaged frames of data. Each frame uses 292 bytes of memory.

The software buffer is always in use regardless of the setting of QPKTS variable. The effect of QPKTS occurs when the buffer is filled. If QPKTS is set to 1, the scan will stop when the buffer is full. If QPKTS is set to 0, subsequent frames will be discarded when the buffer is full.

The buffer is the liaison between the scan task and the scan output task. The scan output task has a higher priority than the scan task. Under initial conditions, when the buffer is empty, the scan task places one frame of data in the buffer. It then signals the scan output task to read the buffer until it is empty. However, when multiple frames of data are in the buffer, the output task continues until the buffer is empty. Multiple frames of data will accumulate if the scan output task is blocked by the network while outputting data.

DSA NETWORK CONFIGURATIONS

The DSA may be configured in three basic network arrangements:

ISOLATED NETWORK

The isolated DSA network provides the fastest possible data throughput because other network traffic has been eliminated. DSA commands are issued from the network client/host and data is directed to the network client/host in UDP format. Data is removed from the client/host via disk or tape. This configuration is ideal for high speed data transfer with data reduction that is handled by the network client/host.

INTEGRATED WITH SYSTEM NETWORK

The integrated DSA provides the most accessible data to all network clients. Any client/host on the network may control any or all of the DSA's. Network throughput (TCP/IP) may be reduced because of other network traffic. This configuration is ideal for systems that can tolerate slower data transfer rates but require easy access by multiple client/hosts to each DSA unit.

SUB-NETWORK WITH GATEWAY

The DSA sub-network allows high speed data transfer of the sub-network while allowing access by a larger network. The gateway is most effective as a multi homed client/host that can store the DSA data for later access by client/hosts on the main system network.

DSA NETWORK ADDRESSING

Each DSA module has the capability to accept commands in Unicast (only one DSA accepts command)

Each DSA module has a unique, factory set, 48 bit physical Ethernet address. When running TCP/IP protocol the DSA modules support ARP (address resolution protocol) to enable the client/host to determine the relationship between the IP address and the Ethernet address. The IP address is user assignable.

[INTENTIONALLY LEFT BLANK]

SECTION 6: MAINTENANCE

CALIBRATION

The DSA3200 series uses a well proven, very stable, temperature compensated TO-8 style piezoelectric pressure sensor. The use of this series of sensors, along with the ability to perform frequent, online zero offset calibrations allows the DSA to hold published accuracy for up to 6 months. Scanivalve recommend validating the DSA with a high-accuracy pressure standard on 6 month intervals and recalibrating the unit as required.

Every DSA module is calibrated from the factory over a series of 9 temperatures between 0°C and 69°C. At each temperature, 9 pressures are applied. This calibration creates a matrix of discrete temperatures and pressures, called Master Calibration Coefficients. The DSA then interpolates between each of these points to create a complete matrix of “calculated” coefficients.

When recalibrating a DSA module, there are three types of calibrations that can be performed:

FULL CALIBRATIONS

A full calibration deletes all calibration coefficients and re-applies known pressures over a series of temperatures. This duplicated exactly what is done at the factory during the module’s original manufacture and calibration. This calibration requires an environmental chamber capable of reaching the entire 0°C and 69°C range and a suitable pressure standard. It is recommended that for a full calibration the module be returned to Scanivalve or a certified Scanivalve Representative.

FIELD CALIBRATIONS

As an alternative to Full Calibrations, Scanivalve offers a free program called “PressCal” that allows any metrology lab with a suitable pressure standard to perform a “Field Calibration.” During a field calibration, a series of pressures are applied to the module at a single temperature. The temperature of the module does **not** have to be controlled to a specific temperature. PressCal calculates a new set of coefficients for that given temperature, then applies a correction to the pressure coefficients across all temperatures. This technique is suitable for maintaining modules long term and has been proven to be just as good as a new full calibration when done properly. More information on PressCal can be found on the Scanivalve website or by contacting Scanivalve.

ZERO OFFSET CALIBRATION

In all piezoelectric pressure sensors, zero drift is the single largest contributor to long term errors. Because of this, all DSA3217 and 3218 modules have internal calibration valves and a software command (CALZ) that allow for a zero offset calibration to be performed easily and frequently. More information on the Zero Offset Correction calibrations can be found in “Zero Offset Calibration” on page 14, and information on the CALB and CALZ commands can be found in “Calibrate Barometric Pressure” on page 23 and “Calibrate Zero” on page 24 respectively.

DSA3200 OPERATING SYSTEM UPLOAD

This section describes the method for upgrading and uploading a new operating system to the DSA3200. Two programs are used in the DSA3200, the boot-loader and the operating system/DSA3200 application, referred to as the operating system.

The purpose of the boot-loader is to start the operating system from local flash or from a location on the network, such as a disk file on a host PC and to allow setting of certain key operating system parameters. The boot-loader can only be installed with special flash programming equipment. However, the boot-loader, under most normal upgrade conditions, would not need to be changed. **Note that not all DSA modules can be updated to the latest firmware. Contact Scanivalve Technical Support for specific information regarding your module.**

When upgrading a new DSA3200 operating system, the following procedure should be followed:

Step 1: Locate the VXWORKS.ST file

Create a new directory on the host computer:
C:\DSA_HS
Place the “vxworks.st” file in it.

Step 2: Install a file server

Install a file server. This procedure shows Mozilla Filezilla Server, but any file server can be used.

Step 3: Configure the file server

For Filezilla, setup a user under “Edit->User”. Create a new user by hitting the “add” button on the right. Set the user name to “DSA_HS”. Then, set the password to “scanivalve” (this must match the DSA configuration, “DSA_HS” and “scanivalve” are the defaults.) [Figure 6.1]

FIGURE 6.1: FILEZILLA USER SETUP

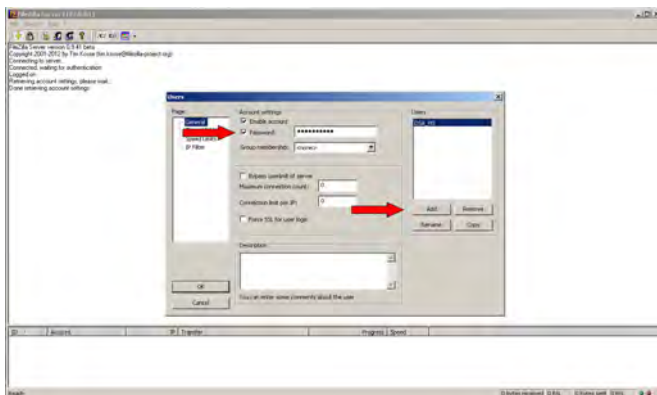

Once a user has been defined, create a share directory by clicking “add” and navigating to the C:\DSA_HS directory containing the vxworks.st file. [Figure 6.2]
*NOTE: Some file servers require the full path and some only require the file name.

FIGURE 6.2: FILEZILLA SHARE SETUP

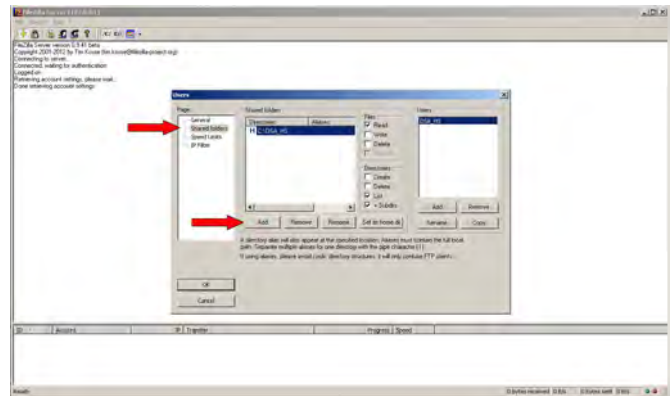

Step 4: Reconfigure the DSA boot parameters

Setup a serial connection through HyperTerminal to the DSA module with the following settings: [Figure 6.3]
Bits Per Second - 9600
Data Bits - 8
Parity - None
Stop Bits - 1
Flow Control - None

FIGURE 6.3: CONFIGURE HYPERTERMINAL

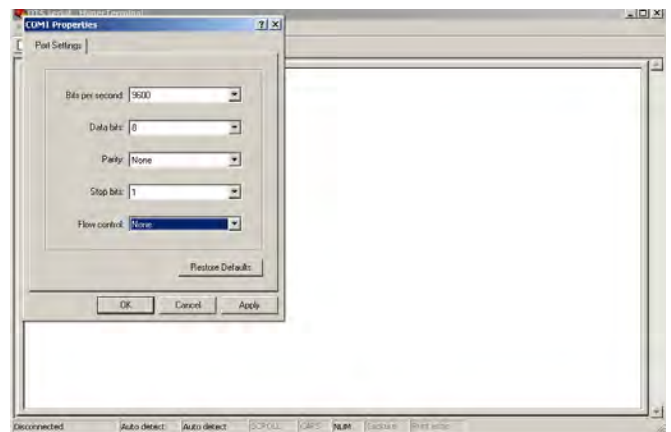

Once a serial connection is established, power up the DSA module. Stop the boot process by hitting any key when prompted. To change the boot parameters, enter “c”. Scroll through with the “enter” key to reach “host inet (h)”. Change this term to the IP Address of the host computer. Continue scrolling through the rest of the boot parameters. Continue the boot process by entering “@”.

Step 5: Connect via HyperTerminal

With the HyperTerminal serial connection still established, in a new HyperTerminal window setup an Ethernet connection with the DSA module.

Step 6: Configure HyperTerminal

Configure the HyperTerminal session by clicking “File->Properties->Settings (tab)->ASCII Setup”
Set the following:

- Send line ends with line feeds - check
- Echo typed characters locally - check
- Line Delay - 100 (milliseconds)
- Character Delay - 10 (milliseconds)

Leave the rest as default. [Figure 6.4]

FIGURE 6.4: CONFIGURE HYPERTERMINAL

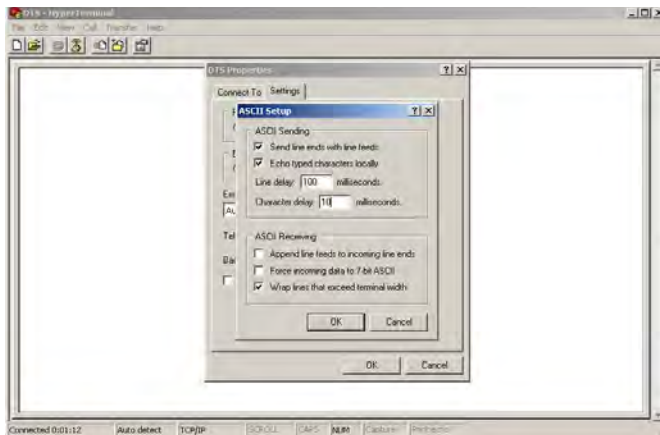

Step 7: Upload the new firmware

Through the Ethernet HyperTerminal connection, send the command (all upper case):

UPLOAD S VXWORKS.ST

Monitor the upload progress through the serial connection. When the scrolling stops, verify the upload is complete with the “STATUS” command through the Ethernet connection. The status should be: “READY”. [Figure 6.5]

FIGURE 6.5: UPLOADING NEW FIRMWARE

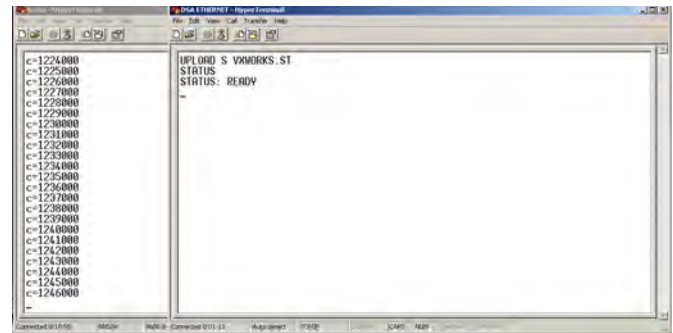

Step 8: Cycle the power

The upload procedure has uploaded the new vxworks.st file into the DSA’s flash memory. The DSA will not run on the new firmware until the power has been cycled. After the power has been cycled, verify the new firmware with the “VER” command.

DSA3200 COEFFICIENT UPLOAD

Step 1: Open ScanTel

Open ScanTel. To configure the connection, click on the “Configuration” button in the top menu bar. Enter the IP Address of the DSA module, set the “Upload Line Delay in MS” field to 30 milliseconds. Verify that the “Device Type” is set as a DSA. Click “OK”.

FIGURE 6.6: OPEN AND CONFIGURE SCANTEL

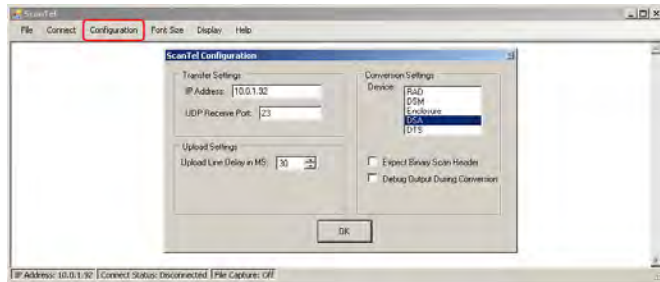

Step 2: Connect to the DSA

In the top menu bar, click the Connect/Disconnect button. Verify that the connection status at the bottom of the window is “Connected.”

FIGURE 6.7: CONNECT TO THE DSA

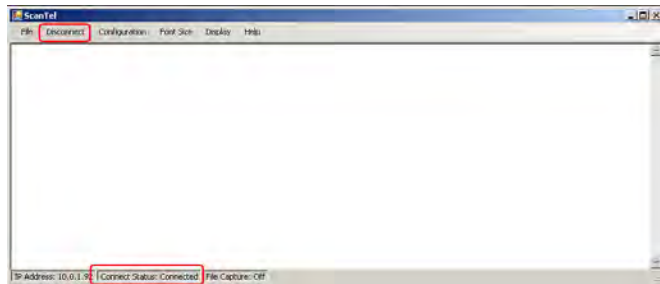

Step 3: Delete old coefficients

Send the command “DELETE 0 69”. Wait approximately 5 seconds, then send the command “SAVE”

FIGURE 6.8: DELETE OLD COEFFICIENTS

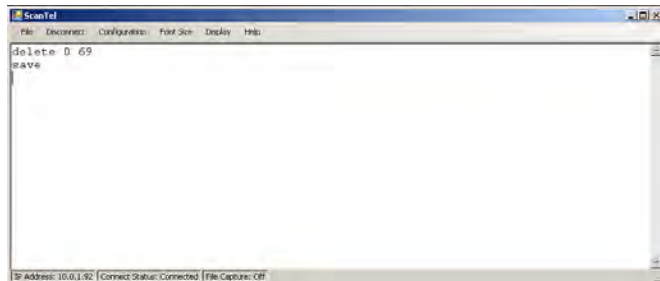

Step 4: Upload new coefficients

In the top menu bar, click File->Upload ASCII File... Browse to and select the new coefficient file.

FIGURE 6.9: UPLOAD NEW COEFFICIENT

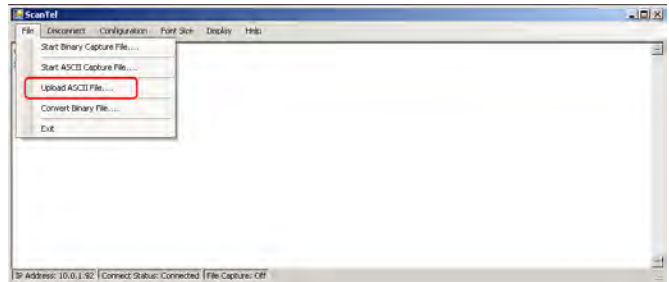

Step 5: Fill calculated coefficients

Once the new master coefficients have been successfully uploaded, you will need to create new calculated coefficients based on the master coefficients. Do this by sending the “FILL” command. Wait approximately 5 seconds, then send the “SAVE” command.

FIGURE 6.10: FILL CALCULATED COEFFICIENTS

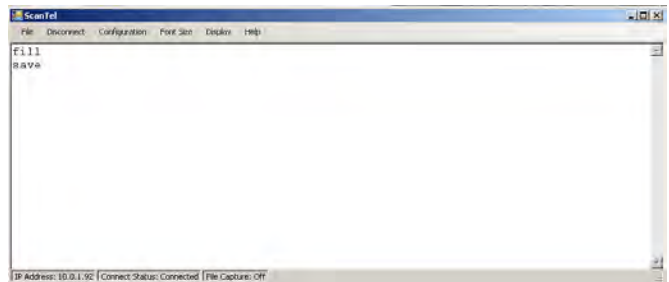

Step 6: Verify new coefficients

Once the save has completed, verify the new coefficients have been successfully uploaded by sending the command “LIST M 0 69 1”. The DSA should return data similar to this, which should also match to data in the original coefficient file:

```

INSERT 0 1 -16.638029 -5622 M
INSERT 0 1 -8.308900 -2769 M
INSERT 0 1 0.000000 71 M
INSERT 0 1 9.200880 3209 M
INSERT 0 1 18.452391 6360 M
INSERT 0 1 27.701389 9509 M
INSERT 0 1 36.952549 12653 M
INSERT 0 1 46.202930 15796 M
INSERT 0 1 55.451382 18933 M
INSERT 15 1 -16.632441 -5596 M
INSERT 15 1 -8.312710 -2755 M
INSERT 15 1 0.000000 79 M
INSERT 15 1 9.195330 3207 M
INSERT 15 1 18.445560 6350 M
INSERT 15 1 27.695351 9491 M
INSERT 15 1 36.945900 12627 M
INSERT 15 1 46.196789 15761 M
INSERT 15 1 55.446602 18891 M
INSERT 30 1 -16.633829 -5586 M
INSERT 30 1 -8.313980 -2746 M
INSERT 30 1 0.000000 88 M
INSERT 30 1 9.197390 3215 M
INSERT 30 1 18.446600 6353 M
INSERT 30 1 27.696341 9496 M
INSERT 30 1 36.946709 12630 M
INSERT 30 1 46.196720 15764 M
INSERT 30 1 55.446640 18895 M
INSERT 45 1 -16.631220 -5585 M
INSERT 45 1 -8.310780 -2741 M
INSERT 45 1 0.000000 96 M
INSERT 45 1 9.203220 3229 M
INSERT 45 1 18.453381 6375 M
INSERT 45 1 27.702049 9519 M
INSERT 45 1 36.952389 12658 M
INSERT 45 1 46.203098 15796 M
INSERT 45 1 55.452808 18930 M
INSERT 59 1 -16.632210 -5602 M
INSERT 59 1 -8.312270 -2751 M
INSERT 59 1 0.000000 93 M
INSERT 59 1 9.195270 3230 M
INSERT 59 1 18.445601 6385 M
INSERT 59 1 27.695971 9536 M
INSERT 59 1 36.945610 12683 M
INSERT 59 1 46.196011 15829 M
INSERT 59 1 55.445351 18970 M
INSERT 64 1 -16.637039 -5628 M
INSERT 64 1 -8.306550 -2770 M
INSERT 64 1 0.000000 74 M
INSERT 64 1 9.199490 3217 M
INSERT 64 1 18.450260 6375 M
INSERT 64 1 27.700529 9529 M
INSERT 64 1 36.951191 12681 M
INSERT 64 1 46.200378 15830 M
INSERT 64 1 55.451019 18975 M
INSERT 69 1 -16.631960 -5654 M
INSERT 69 1 -8.311050 -2795 M
INSERT 69 1 0.000000 55 M
INSERT 69 1 9.194890 3199 M
INSERT 69 1 18.445190 6363 M
INSERT 69 1 27.694960 9521 M
INSERT 69 1 36.944241 12677 M
INSERT 69 1 46.194248 15830 M
INSERT 69 1 55.445580 18979 M
    
```

DSA3200 SENSOR REPLACEMENT

The piezoelectric pressure sensors in the DSA module are field replaceable. If a sensor needs to be replaced, contact Scanivalve Technical Support before attempting to change a sensor. New sensors can be obtained from Scanivalve or any official Scanivalve Representative. Extreme caution should be taken when changing a sensor.



CAUTION! ESD protection is required for this procedure. Failing to follow ESD protection guidelines could cause permanent damage to the DSA electronics.

The procedure shows a DSA3217 module, but the procedure is very similar for a DSA3218. Simply remove the top and side of the DSA3218 enclosure, remove the “core” assembly and pick up the procedure at step 4.

The following equipment is required:

- ESD protection
- #1 phillips screw driver
- #2 phillips screw driver
- 5/64” allen wrench
- 3/32” allen wrench

Step 1: Remove the bottom mounting plate

Using a #2 phillips screwdriver, remove the 4 screws that attach the bottom mounting plate.

FIGURE 6.11: REMOVE BOTTOM MOUNTING PLATE



Step 2: Remove the top plate

Using a 3/32” allen wrench, remove the 8 allen screws holding the top plate on. These are “captive” screws so they do not have to be completely removed.

FIGURE 6.12: REMOVE TOP PLATE



Step 3: Remove the case half screws

Using a #2 phillips screwdriver, remove the two remaining screws that are securing the two case halves together.

FIGURE 6.13: REMOVE THE CASE HALVE SCREWS



Step 4: Separate the case halves

Gently separate the two case halves from each other. Make sure to pull squarely to prevent damage to the A/D board interface connector.

FIGURE 6.14: SEPARATE THE CASE HALVE SCREWS



Step 5: Disconnect the ground wire

Using a #1 phillips screwdriver, disconnect the ground wire.

FIGURE 6.15: REMOVE THE GROUND WIRE



Step 6: Disconnect the Quick Zero solenoid

Carefully disconnect the quick zero solenoid from the processor board.

FIGURE 6.16: DISCONNECT THE QUICK ZERO SOLENOID



Step 7: Remove the “core” from the case half

Using a #2 phillips screwdriver, remove the 4 screws that hold the core into the case half. Carefully remove the core from the case half.

FIGURE 6.17: REMOVE THE CORE

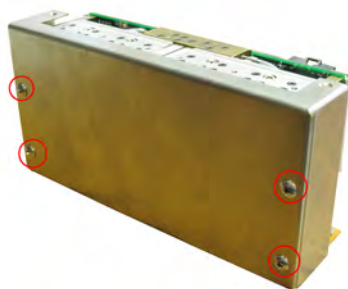

Step 8: Remove the insulators

Using a #2 phillips screwdriver, remove the 8 counter sunk screws that hold the insulators in place.

FIGURE 6.18: REMOVE THE INSULATORS



Step 9: Remove the Quick Zero Solenoid and manifold

Using a 5/64” allen wrench, remove the quick zero solenoid and the manifold from the end of the core.

*NOTE: Only the manifold from the related sensor pack needs to be removed. If changing a sensor in position 1-8, the quick zero solenoid can be left in place.

FIGURE 6.19: REMOVE THE MANIFOLD



Step 10: Remove the reference manifold

Using a #2 phillips screwdriver, remove the reference manifold from the appropriate sensor pack. Gently and squarely pull the reference manifold from the sensor housing.

FIGURE 6.20: REMOVE THE REFERENCE MANIFOLD

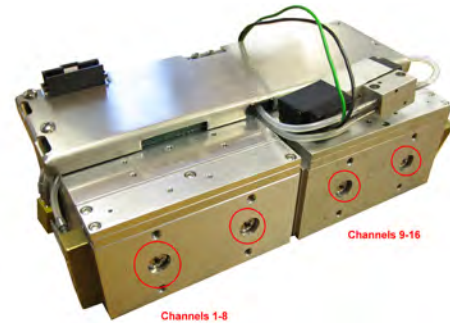
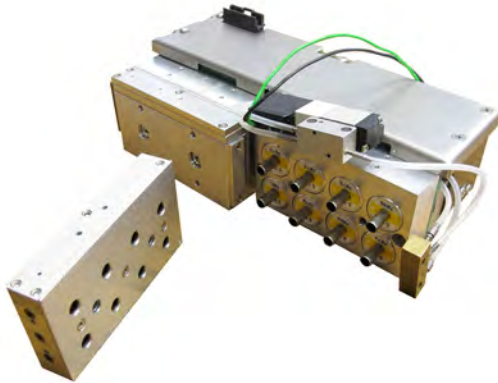
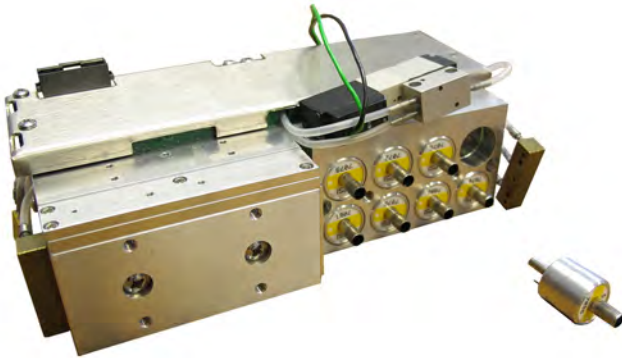

FIGURE 6.21: REMOVE THE REFERENCE MANIFOLD**Step 11: Replace the sensor**

Gently pull the sensor out that needs to be replaced.

Note the position of the alignment pin when installing the new sensor. The sensor shown removed in this image is from position #15.

FIGURE 6.22: REMOVE THE SENSOR

Reassemble the module in the reverse order as the disassembly process. After replacing a sensor, the new calibration coefficients for that sensor will need to be uploaded to the module in order for it to work properly. Scanivalve provides a free utility program called the "Sensor Replacement Utility" that makes this task very simple. The Sensor Replacement Utility can be downloaded for free from the Scanivalve website at <http://www.scanivalve.com/support/software-downloads/>.

DSA3200 GENERAL CHECKOUT PROCEDURE

The following is a high-level checkout procedure for the DSA3200 series modules. This can be used as a verification that the module is fully functional before implementing it into a system, or as a diagnostic check if it is suspected that the module is not functioning correctly. Ensure that the module has been warmed up for at least 1 hour before beginning this procedure. This procedure does not verify the accuracy of the module. If the module fails this procedure in any way, contact Scanivalve for additional support.

Begin by configuring the module for the test, with the following settings:

SET FORMAT 1	SET FPS 0
SET AVG 16	SET XSCANTRIG 0
SET PERIOD 500	SET BIN 0

1. Check raw pressure and temperature readings

Send the following commands:

SET EU 0
SET ZC 0
SCAN

- The raw pressure readings should all be ± 500 counts
- The raw temperature readings (at room temp) should be between -15,000 and +10,000 counts

STOP the scan.

2. Verify the CALZ function

Send the following commands:

SET ZC 1
CALZ (wait for the CALZ to complete)
SCAN

- The raw pressure readings should all be ± 5 counts

STOP the scan.

3. Verify the Engineering Unit Conversion

Send the following commands:

SET EU 1
SCAN

- The pressure readings should be extremely close to 0.0psi
- The temperature readings should be between 3°C and 5°C above the ambient temperature

4. Verify the reference response

With the unit still scanning, apply between 75 and 100% of full scale pressure (or 15 psi maximum) to the reference port(s) on the module.

- This should result in a negative reading on all channels.

5. Check for leaks in the reference plumbing

With the unit still scanning, trap the pressure on the reference port(s).

- Monitor the pressures for 60 seconds, a pressure drop of up to 0.1% of full scale is acceptable.

Vent the pressure off of the reference port(s).

6. Verify individual Px response

With the unit still scanning, apply between 75 and 100% of full scale pressure individually to all 16 Px inputs.

- This should result in a believable positive pressure on only the one channel with pressure applied.

7. Verify the calibration input (CAL) response

Apply 90-120 psi to the CTL1 and CTL2 ports to put the DSA module into calibration mode.

With the unit still scanning, apply between 75 and 100% of full scale pressure to the CAL port(s)

- This should result in a believable positive pressure on all 16 channels.

8. Check for leaks in the calibration plumbing

With the unit still scanning, trap the pressure on the calibration port(s).

- Monitor the pressures for 60 seconds, a pressure drop of up to 0.1% of full scale is acceptable.

Vent the pressure off of the calibration port(s).

Vent the pressure off the CTL1 and CTL2 ports.

STOP the scan.

9. Check for drifting/unstable sensors

Send the following commands:

SET EU 0

CALZ (wait for the CALZ to complete)

SCAN

Monitor all 16 channels

- All sensor readings should stay stable within 4 counts for 1 minute.

STOP the scan.

10. Check for noisy output

Send the following commands:

SET AVG 4

SCAN

Monitor all 16 channels for 1 minute, watching for any "spiking" data.

- All readings should stay within ± 20 counts from the original reading for the duration of the 1 minute test.

11. OPTIONAL Purge test

Apply 90-120 psi to the CTL1 and CTL2 ports

Apply 90-120 psi to the PRGCTL port

Apply the desired purge pressure to the PRG port

- Verify that purge pressure is flowing out of all 16 Px input ports

- Verify that there is no purge pressure flowing out of any other port

APPENDIX

APPENDIX A: TEMPERATURE COMPENSATED PRESSURE CONVERSION

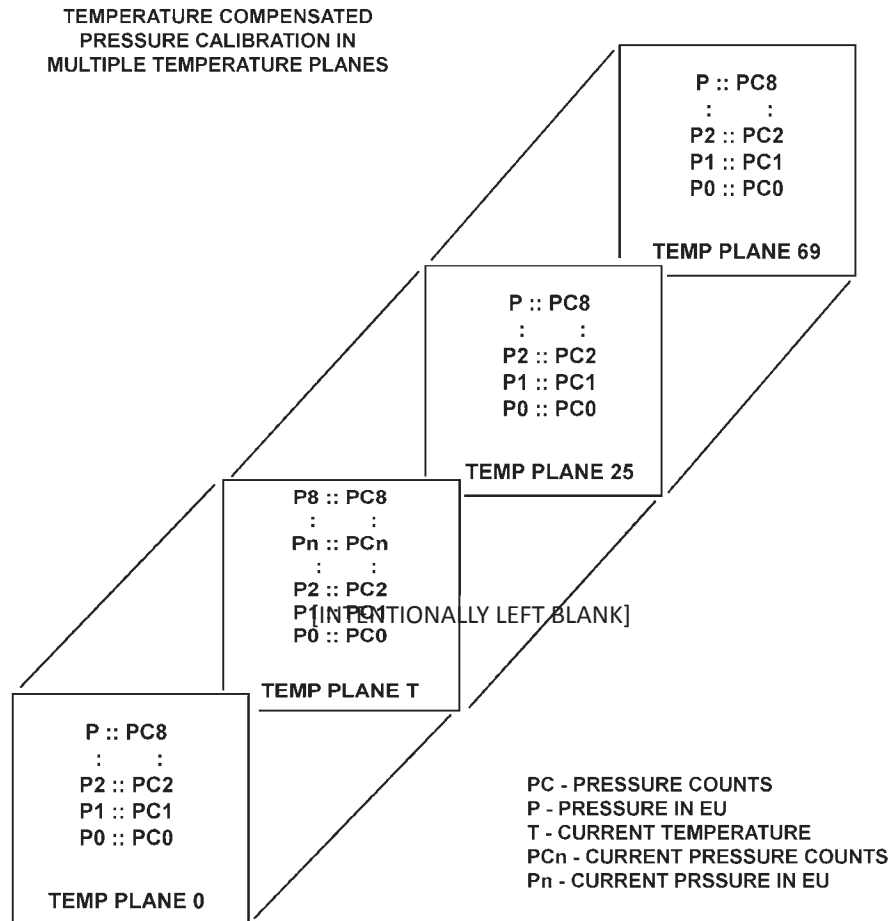

Formulas:

Pressure interpolation within current temperature plane:

$$P_{nt} = \frac{1}{PC_{1t} - PC_{0t}} ((PC_{1t} - PC_{nt})P_{0t} - (PC_{0t} - PC_{nt})P_{1t})$$

Calculation of entries in current temperature plane:

$$P_t = \frac{1}{T_{25} - T_0} ((T_{25} - T)P_{00} - (T_0 - T)P_{025})$$

APPENDIX B: ENGINEERING UNIT CONVERSION CONSTANTS

UNITSCAN Setting	Engineering Unit	PSI to EU 1 psi =	EU to PSI 1 EU =
ATM	Atmospheres	0.068046 A	14.6960 psi
BAR	Bars	0.068947 b	14.5039 psi
CMHG	Centimeters of Mercury	5.17149 cmHg	0.193368 psi
CMH2O	Centimeters of Water	70.308 cmH ₂ O	0.014223 psi
DECIBAR	Decibar	0.68947 db	1.4504 psi
FTH2O	Feet of Water	2.3067 ftH ₂ O	0.43352 psi
GCM2	Gram per square Centimeter	70.306 g/cm ²	0.014224 psi
INHG	Inch of Mercury @ 0°C	2.0360 inHg	0.491159 psi
INH2O	Inch of Water @ 4°C	27.0680 inH ₂ O	0.36127 psi
KGCM2	Kilogram per square Centimeter	0.703070 kg/cm ²	14.2235 psi
KGM2	Kilogram per square Meter	703.069 kg/m ²	0.0014223 psi
KIPIN2	kips per square inch (ksi)	0.001kip/in ²	1000.0 psi
KNM2	Kilonewton per square Meter	6.89476 kN/m ²	0.145038 psi
KPA	Kilopascal	6.89476 kPa	0.145038 psi
MBAR	Millibar	68.947 mb	0.014504 psi
MH2O	Meter of Water	0.70309 mH ₂ O	1.42229 psi
MMHG	Millimeter of Mercury	51.7149 mmHg	0.0193368 psi
MPA	Megapascal	0.00689476 MPa	145.039 psi
NCM2	Newton per square Centimeter	0.689476 N/cm ²	1.45038 psi
NM2	Newton per square Meter	6894.76 N/m ²	0.000145038 psi
OZFT2	Once per square Foot	2304.00 oz/ft ²	0.000434028 psi
OZIN2	Ounce per square Inch	16.00 in/ft ²	0.062500 psi
PA	Pascal	6894.76 Pa	0.000145038 psi
PSF	Pound per square Foot	144.00 lb/ft ²	0.00694444 psi
TORR	Torr	51.7149 T	0.0193368 psi

APPENDIX C: DSA3200 ERROR LIST**BOOT/INITIALIZATION ERRORS**

ERROR: Could not create a socket
 Fatal Error - The DSA Module has a hardware problem.
 ERROR: Could not bind a socket
 Fatal Error - The DSA Module has a hardware problem.
 ERROR: Could not listen on a socket
 Fatal Error - The DSA Module has a hardware problem.
 ERROR: accept slave socket
 Fatal Error - The DSA Module has a hardware problem.

SET CONFIGURATION VARIABLE ERRORS

ERROR: Model value not valid
 The model value is not 3207, 3217 or 3218
 ERROR: PORT value not valid
 Port is not a valid Windows Port number
 ERROR: HOST value not found
 ERROR: HOST server port value not valid
 The host port was not entered or is an invalid or reserved port number
 ERROR: HOST IP address value not valid
 The host IP address entered is not a valid address
 ERROR: PMaxH value not valid
 ERROR: PMaxL value not valid
 The value for the variable was not entered or is not numeric.
 ERROR: PMinH value not found
 ERROR: PMinH value not valid
 The value for the variable was not entered or is not numeric.
 ERROR: PMinL value not found
 ERROR: PMinL value not valid
 The value for the variable was not entered or is not numeric.
 ERROR: NegPts value not valid
 ERROR: NegPts channel value invalid
 The value for the variable was not entered or is not numeric.
 ERROR: NegPts channel not between 0 and 15
 The number entered was negative or greater than 15
 ERROR: NegPtsH value not found
 ERROR: NegPtsH value not valid
 The value for the variable was not entered or is not numeric.
 ERROR: NegPtsL value not found
 ERROR: NegPtsL value not valid
 The value for the variable was not entered or is not numeric.
 ERROR: NegPtsH not between 0 and 8
 ERROR: NegPtsL not between 0 and 8
 The number entered was negative or greater than 8
 ERROR: Abs value not found
 ERROR: Abs value not valid

ERROR: Abs channel value invalid
 The number entered was negative or greater than 15
 ERROR: Abs channel not between 0 and 15
 The number entered was negative or greater than 15
 ERROR: Max value not valid
 ERROR: Max channel value invalid
 The value for the variable was not entered or is not numeric.
 ERROR: Max channel not between 0 and 15
 The number entered was negative or greater than 15
 ERROR: Min value not valid
 ERROR: Min channel value invalid
 The value for the variable was not entered or is not numeric.
 ERROR: Min channel not between 0 and 15
 The number entered was negative or greater than 15
 ERROR: Period value not valid
 The value for the variable was not entered or is not numeric.
 ERROR: Period value below range
 ERROR: Period value above range
 The value entered was less than 125 or greater than 65535
 ERROR: FPS value not valid
 The value for the variable was not entered or is not numeric.
 ERROR: EU value not valid
 ERROR: QPKTS value not valid
 ERROR: ZC value not valid
 ERROR: BIN value not valid
 ERROR: FORMAT value not valid
 ERROR: XSCANTRIG value not valid
 ERROR: PAGE value not valid
 ERROR: ECHO value not valid
 The value for the variable was not 0 or 1.
 ERROR: TIME value not valid
 The value for the variable was not 0, 1 or 2.
 ERROR: AVG value not valid
 The value for the variable was not entered or is not numeric.
 ERROR: Average value below range
 ERROR: Average value above range
 The value entered was less than 1 or greater than 240
 ERROR: UnitScan value not valid
 The value for the variable was not entered.
 ERROR: UnitScan did not find unit name in table
 The value for the variable is not on the master list.
 Refer to the software specification for a list of valid names.
 ERROR: CvtUnit value not valid
 The value for the variable was not entered or is not numeric.
 ERROR: Tempb value not valid

ERROR: TempB channel value invalid
The value for the variable was not entered or is not numeric.

ERROR: TempB channel not between 0 and 15
The number entered was negative or greater than 15

ERROR: Tempm value not valid

ERROR: TempM channel value invalid
The value for the variable was not entered or is not numeric.

ERROR: TempM channel not between 0 and 15
The number entered was negative or greater than 15

ERROR: SerNum value not valid
The value entered is not numeric

ERROR: Npr value not valid
The value entered is not numeric

ERROR: DEF channel not valid
The channel value entered is negative or not numeric

ERROR: DEF channel not between 0 to 15
The number entered was negative or greater than 15

ERROR: CALB baro value not valid
The value was not entered, negative, or not numeric

ERROR: CALB period value not valid
The value entered was outside the range of the PERIOD variable.

ERROR: CALB average value not valid
The value entered was less than 1 or greater than 240.

ERROR: Calb data error
Fatal hardware error - The module did not enter or complete the scan.

ERROR: CALZ period value not valid
The value entered was outside the range of the PERIOD variable.

ERROR: CALZ average value not valid
The value entered was less than 1 or greater than 240.

ERROR: Calz data error
Fatal hardware error - The module did not enter or complete the scan.

ERROR: Zero value not valid

ERROR: Zero channel value invalid
The value for the variable was not entered or is not numeric

ERROR: Zero channel not between 0 and 15
The number entered was negative or greater than 15

ERROR: Delta value not valid

ERROR: Delta channel value invalid
The value for the variable was not entered or is not numeric

ERROR: Delta channel not between 0 and 15
The number entered was negative or greater than 15

ERROR: Dout channel not present
The DOUT channel and condition was not entered

ERROR: Dout channel invalid
The DOUT channel number entered less than 1, greater than 5, or not numeric.

ERROR: Dout data missing
The DOUT condition was not entered

ERROR: Dout data value not valid
The DOUT condition was not 0 or 1

COMMAND ERRORS

ERROR: Mode ready, invalid command

ERROR: Invalid command
The command entered was not a DSA command

ERROR: Invalid set parameter
The configuration variable entered was not a DSA variable

ERROR: Invalid list parameter
The list parameter was not A, B, C, D, G, H, I, L, M, N, O, S, or Z.

ERROR: UPLOAD <S or C> value not found
S or C was not entered or was lower case

ERROR: UPLOAD file name not found
The file name was not entered, does not exist, or has an invalid path

ERROR: Insert's temp value not valid
The temperature values were either not entered, negative, or not numeric

ERROR: Insert's temp above <max temp>
The temperature value entered was greater than 69

ERROR: Insert's chan value not valid
The channel value was not entered or not numeric.

ERROR: Insert's chan above 15
The channel value entered was greater than 15

ERROR: Insert's pressure value not valid
The pressure value entered was not numeric

ERROR: Insert's type not valid

ERROR: Insert's type must be M
The insert type must be M

ERROR: LIST M start temp not valid
The start temp entered was less than 0, greater than 69, or not numeric

ERROR: List M start temp above <max temp>
The start temp entered was greater than 69

ERROR: LIST M stop temp not valid
The stop temp entered was less than start temp, not numeric, or greater than 69

ERROR: List M stop temp above <max temp>
The stop temp entered was greater than 69

ERROR: LIST A start temp not valid
The start temp entered was less than 0, greater than 69, or not numeric

ERROR: List A start temp above <max temp>
The start temp entered was greater than 69

ERROR: LIST A stop temp not valid
The stop temp entered was less than start temp, not numeric, or greater than 69

ERROR: List A stop temp above <max temp>
The stop temp entered was greater than 69

ERROR: DELETE start temp value not found
The start temp was not entered or was not numeric

ERROR: DELETE start temp not valid
The start temp entered was less than 0, greater than 69, or not numeric

ERROR: DELETE stop temp value not found
The stop temp was not entered or was not numeric

ERROR: DELETE stop temp not valid
The stop temp entered was less than 0, greater than 69, or not numeric

ERROR: Delete start temp above <max temp>
The start temp entered was greater than 69

ERROR: Delete stop temp above <max temp>
The stop temp entered was greater than 69

ERROR: Max errors exceeded
The error buffer is full - more than 15 errors have been detected

ERROR: No Errors
No errors have been detected - this is the normal response to the error command

ERROR: Receive message queue
The command received is too long, or too many commands have been sent before the DSA Module can process them.

COMMUNICATION ERRORS

ERROR: Closing slave socket with read error
Fatal Error - The DSA Module has a hardware problem.

ERROR: Could not spawn Tcp Server
Fatal Error - The DSA Module has a hardware problem.

ERROR: Could not spawn Udp Id Server
Fatal Error - The DSA Module has a hardware problem.

ERROR: Could not spawn Udp Server
Fatal Error - The DSA Module has a hardware problem.

ERROR: Could not create a UDP socket
Fatal Error - The DSA Module has a hardware problem.

ERROR: Could not bind a UDP socket
Fatal Error - The DSA Module has a hardware problem.

ERROR: sending UDP bytes
Fatal Error - The DSA Module has a hardware problem.

ERROR: Alignment error
Fatal Error - The DSA Module has a hardware problem parsing the data

ERROR: Allignment rb%lu f%1IX lbx%1IX lb%1IX px%1IX p%1IX cx%1IX c%1IX",
Fatal Error - The DSA Module has a hardware problem parsing the data.

ERROR: Data buffer overflow
The data buffer is full - The TCP/IP connection may be disconnected

ERROR: Send message queue
The TCP/IP connection may be disconnected or the scan speed os too fast for the network.

ERROR: Send queue is full
The TCP/IP connection may be disconnected or the scan speed os too fast for the network.

APPENDIX D: SOFTWARE CHANGE LOG

- Version 1.00 - Released April 2000
First Release
- Version 1.01 - Released April 18, 2000
Corrected bug in the Dual Range Configuration
Added Dual Range capability
- Version 1.02 - Released July 18, 2000
Added the Calibrate Command
Added Page Mode Variable to the SCAN group - this is active only when in UDP mode
- Version 1.03 - Released August 23, 2000
Added support for the DSA3207
- Version 1.04 - Released March 2001
Added Software Trigger
TRIG command or <TAB> character
- Version 1.05 - Released June 29, 2001
Increased upper temperature plane limit to 79 degrees Celsius
- Version 1.06 - Released March 2002
Modified bootloader to support new or old flash chips
Added Variable PORT to the I Group to permit Ethernet ports other than 23
- Version 1.07 - Released April 2003
Added HOST configuration variable for binary data transmission support.
- Version 1.08 - Released June 2005
Modified the operation below 0 degrees C. If the sensor temperature is less than 0 degrees C, the EU conversion will use the last good set of coefficients. No error will be indicated.
- Version 1.09 - Released January 2006
Added CALB command to permit adjustment of the ambient pressure reading of absolute sensors
- Version 1.10 - Released January 2007
Disabled the Nagle Algorithm in TCP and UDP data transmission. This will guarantee one frame per packet in either data transmission.
- Version 1.11 - Released June 2008
Modified the EU conversion to output 999999 if the measured pressure exceeds the maximum positive pressure setting or -999999 if the measured pressure exceeds the maximum negative pressure.
Extended the upper temperature range of the coefficient file to 79 degrees C. The software will use the last master plane coefficients for all EU conversions above 69 degrees C. The module will output 999999 when the temperature reaches 79 degrees C.
- Version 1.12 - Released January 2010
Added optional parameters to the CALB and CALZ commands to permit a user to set the period and average to be used for these commands.
Added another optional parameter to the CALZ command to set the time delay.

Version 1.13 - Released September 2010

Modified the Overpressure and "Off table" indication. The output will be 999999 or -999999 no matter what UNITSCAN is set to. This value was being multiplied by the conversion factor in UNITSCAN

Version 1.14 - Released April 2011

Corrected a packet identification bug in the software. Packet 5 was designated for output when Packet 7 should have been output

Corrected the identification of the time stamp units in the binary file.

Version 1.15 - Released September 2012

Added the option to increase the temperature resolution. Added LIST T command as well as ENTI and TMPDP variables. This increased temperature resolution can be enabled to provide smoother transitions between temperature planes for engineering unit conversion. Maximum data speed is decreased when this feature is enabled.

Version 1.16 - Released September 2014

Improved the temperature interpolation/resolution algorithm allowing full speed data collection. Removed LIST T and both variables as they are no longer applicable. Resolved a bug that lead to missing data after several scans of UDP data.

Version 1.17 - Released January 2015

Resolved a bug that produced bad temperature data when AVG was set to specific values. Removed unnecessary debug output from the serial port on power up.

[INTENTIONALLY LEFT BLANK]

Scanivalve

**1722 N. MADSON ST.
LIBERTY LAKE, WA 99019**

**PHONE: 1-800-935-5151
1-509-891-9970
FAX: 1-509-891-9481**

**SCANCO@SCANIVALVE.COM
WWW.SCANIVALVE.COM**

**DSA3200 MANUAL
JANUARY 15, 2015**