

DTS3250 Thermocouple Scanner Instruction and Service Manual

Software Version 2.05

0801

1722 North Madison Street
Liberty Lake, WA 99019
Tel: (800) 935-5151
(509) 891-9970
Fax: (509) 891-9481
web site: www.scanivalve.com
e-mail: scanco@scanivalve.com



Table of Contents

Specifications	1
General Description	2
DTS3250 Versions	3
Screw Terminal Version	3
Panel Jack Version	3
Temperature Measurement Basics	4
DTS Network/Firmware	5
DTS3250 Dimensions	6
Power Requirements	7
Trigger Requirements	8
Hardware Trigger	8
Software Trigger	8
RS 232 Communications	9
ETHERNET CONNECTIONS	10
10Base-T	10
DTS CONTROL AND CONFIGURATION	11
DTS COMMANDS	11
COMMAND LIST	12
A/D CALIBRATION	12
AUTOSTATUS	12
CLEAR	13
CLOSE HOST BINARY SERVER CONNECTION	13
CONNECT TO HOST BINARY SERVER	14
ENTER CHANNEL CALIBRATION SETPOINTS	14
ENTER RTD CALIBRATION SETPOINTS	15
ERROR	15
FILL	15
HOST BINARY SERVER COMMAND	16
LIST CALIBRATION	16
LIST CHANNEL CORRECTION SETPOINTS	16
LIST CONFIGURATION VARIABLES	17
LIST GAIN	17
LIST IDENTIFICATION	18
LIST LABELS	18
LIST LIMITS	19
LIST OFFSET	20
LIST RTD CORRECTION VALUES	20

LIST RTD CONVERSION VALUES	21
LIST SCAN	21
LIST TYPE	22
LIST UTR CALIBRATION VARIABLES	22
OPEN THERMOCOUPLE TEST	23
REBOOT	23
SAVE	23
SCAN	24
SCAN TRIGGER	25
SET	26
STATUS	26
STOP	27
UPLOAD	27
VERSION	27
CONFIGURATION VARIABLES	28
SCAN VARIABLES (Group S)	28
AVG	28
BIN	28
FORMAT	28
FPS	28
PERIOD	29
QPKTS	29
RANGET	29
RANGEV	29
TIME	30
UNITS	30
XSCANTRIG	30
CHANNEL CORRECTION VARIABLES (Group P)	31
PT	31
IDENTIFICATION VARIABLES (Group I)	32
AUTOCON	32
SIM	32
ECHO	32
HOST	32
HOSTCMD	32
RTDMAXSLEW	33
TCMAXSLEW	33
TITLE1	33
TITLE2	33
CALIBRATION VARIABLES (Group C)	34
CALAVG	34
NUMPTS	34
NUMCOEF	34
LIMIT VARIABLES (Group LI)	35
LIMIT	35
CHANNEL LABELS (Group LA)	35
LABEL	35
THERMOCOUPLE VARIABLES (Group T)	36
TYPE <channel>	36
RTD CORRECTION VARIABLES (Group RP)	38
RPT	38
RTD CONVERSION VARIABLES (Group RTDP)	39

RTDP	39
RTDNUMPT	39
RTDNUMCOEF	39
RTDX1	39
RTDX2	40
CHANNEL GAIN CORRECTION VARIABLES (Group G)	40
GAIN	40
CHANNEL OFFSET CORRECTION VARIABLES (Group O)	40
OFFSET	40
RTD CALIBRATION VARIABLES (Group U)	41
MAXDELTA	41
RNUMPTS	41
RNUMCOEF	41
RTDB1	41
RTDB2	42
RTDM1	42
RTDM2	42
DTS Packet Definitions	43
Packet Type Table	43
Host Control Packet: Type 1	43
Command Packet	43
DTS to HOST	44
Binary Data Packet	44
ASCII Packet	44
Network Protocols Supported	45
DTS3250 Recommended Operation	45
Special Operational Notes	45
DTS Web Server	46
Web Server Operation	47
Home	48
Links	48
Help	48
Config	49
Scan	49
Type	50
General	51
Status	52
Error	52
Channel	52
Data	53
Values	53
Windows	53
Data Display	53
Bar	53
Line	53
Log	54
Internet Explorer Setup	54
Netscape Navigator Setup	56

Data Log Setup	56
Bar	57
Line	57
Calibrate	57
Support	58
DTS3250 Boot Parameter Modification	59
Boot parameters and their functions	61
DTS3250 Operating System Upload	62
DTS3250 Buffer Description	62
WarFTP Server	63
Installation	63
Configuration and Setup	65
Appendix A - Accessories	70
Power Supply - PDM 1000	70
Power Supply - PDM 3200	71
Appendix B - Thermocouple Information	72
Thermocouple Basics	72
Law of Homogeneous Materials	72
Law of Intermediate Materials	72
Law of Successive or Intermediate Temperature	72
Thermocouple Circuits	72
Thermocouple Accuracy	73
Relative Accuracy	73
Absolute Accuracy	73
Thermocouple Calibration	73
Sources of Error in Thermocouple Measurements	73
Measuring Junction	73
Extension Wires	73
Reference Junctions	74
Copper Connecting Wires	74
Thermocouple Switches	74
Noise in Thermocouple Circuits	74
Thermocouple Design	75
Size	75
Shape	75
Response	75
Heat Conduction	75
Sensor Position	75
Thermocouple Types and Descriptions	75
Type E - Chromel Constantan	75
Type J - Iron Constantan	75
Type K - Chromel Alumel	76
Type N	76
Type R	76
Type S	76
Type T - Copper Constantan	76
International Thermocouple and Extension Wire Color Codes	77

Appendix C - DTS 3250 Calibration Procedure	78
Appendix D - Change Log	88

Figures and Illustrations

Figure 1 - DTS3250	2
Figure 2 - DTS3250 Block Diagram	4
Figure 3 - Typical Pressure/Temperature Scanning System	5
Figure 4 - DTS3250 Dimensions	6
Figure 5 - Digital Sensor Array Power Wiring	7
Figure 6 - Trigger wiring	8
Figure 7 - RS232/ External Trigger Test Cable	9
Figure 8 - DTS3250 10Base-T cables	10
Figure 9 - Bonded Thermocouple, No Shield	36
Figure 10 - Unbonded Thermocouple, No Shield	36
Figure 11 - Shielded Thermocouple, Shield connected at the DTS	37
Figure 12 - Shielded Thermocouple, Shield connected at the source	37
Figure 13 - Unterminated Probe	37

Command List

ADCAL	12
AUTOSTATUS	12
CLEAR	13
CLOBIN	13
CONBIN	14
PT <index> <volts> [channel]	14
RPT <index> <volts>	15
ERROR	15
FILL	15
HOST <command>	16
LIST C	16
LIST P <channel>	16
LIST A	17
LIST G <channel>	17
LIST I	18
LIST LA	18
LIST LI	19
LIST O <channel>	20
LIST RP	20
LIST RTDP <channel>	21
LIST S	21
LIST T <channel>	22
LIST U	22
OTC	23
REBOOT	23
SAVE	23
SCAN	24
TRIG	25
SET <name> <value>	26
STATUS	26
STOP	27
UPLOAD <S or C><filepath\filename>	27
VER	27

Configuration Variables

SCAN VARIABLES (Group S)	28
AVG <value>	28
BIN <code>	28
FORMAT <code>	28
FPS <value>	28
PERIOD <value>	29
QPKTS <code>	29
RANGET <low range temp value> <high range temp value>	29
RANGEV <low range volt value> <high range volt value>	29
TIME <code>	30
UNITS <type>	30
XSCANTRIG <code>	30
CHANNEL CORRECTION VARIABLES (Group P)	31
PT <channel> <index> <volts applied> <counts applied>	31
IDENTIFICATION VARIABLES (Group I)	32
AUTOCON <code>	32
SIM <code>	32
ECHO <code>	32
HOST <IP address> <port>	32
HOSTCMD <ASCII string>	32
RTDMAXSLEW <value>	33
TCMAXSLEW <value>	33
TITLE1 <title>	33
TITLE2 <title>	33
CALIBRATION VARIABLES (Group C)	34
CALAVG <value>	34
NUMPTS <points>	34
NUMCOEF <coef>	34
LIMIT VARIABLES (Group LI)	35
LIMIT <channel> <enable> [<high limit> low limit>]	35
CHANNEL LABELS (Group LA)	35
LABEL <channel> <label>	35
THERMOCOUPLE VARIABLES (Group T)	36
TYPE <channel> <type> [shield connect]	36
RTD CORRECTION VARIABLES (Group RP)	38
RPT <index> <volts applied> <counts applied>	38
RTD CONVERSION VARIABLES (Group RTDP)	39
RTDP <channel> <index> <temp> <ohms>	39
RTDNUMPT <points>	39
RTDNUMCOEF <coef>	39
RTDX1 <value>	39
RTDX2 <value>	40
CHANNEL GAIN CORRECTION VARIABLES (Group G)	40
GAIN <channel> <gain value>	40
CHANNEL OFFSET CORRECTION VARIABLES (Group O)	40
OFFSET <channel> <gain value>	40
RTD CALIBRATION VARIABLES (Group U)	41

MAXDELTA <value>	41
RNUMPTS <points>	41
RNUMCOEF <coef>	41
RTDB1 <value>	41
RTDB2 <value>	42
RTDM1 <value>	42
RTDM2 <value>	42

Specifications

Inputs (Tx): 16 pairs of screw terminals plus shields.
Optional Panel Jack connections available

ThermocoupleTypes: E, J, K, N, R, S, and T

DTS3250 Accuracy:

Accuracy Table*	
Thermocouple Type	Accuracy
E, J, K, N, and T	±0.5 EC (25 microvolts)
R and S	±2.0 EC (25 microvolts)

UTR Accuracy:(cold junction gradient) ±0.1EC

A/D Resolution: 22 Bit

Scan Rate: 10 samples/channel/second

Operating Temperature: -30EC to 55EC

Communication: Ethernet 10Base-T (standard)
RS-232 (Configuration Only)

Communication Protocol: TCP/IP or UDP

Mating Connector Type:
 Ethernet Bendix PT06A-8-4S-SR, 4 pin female
 Power Bendix PTO6A-8-3S-SR, 3 pin female
 Trigger/Configuration Bendix JTO6RE8-6S-SR, 6 pin female

Power (20-36Vdc): 28Vdc nominal @ 2.5A during warmup, 0.5A quiescent

External Trigger: 9 to 15 Vdc @ 6mA minimum, leading edge sensing

Common Mode Rejection: 160 db @ 0 - 60 Vdc

Weight: Standard Unit: 13.0 pounds(5.91 kg)
Panel Jacks: 12.0 pounds(5.45 kg)

Input/Output Isolation: 1000 Vdc

CE Mark Standards*: IEC 1000-4.2, 1000-4.3, 1000-4.5

* System accuracy specifications are valid after a four(4) hour warm up period.
Accuracy does not include Thermocouples, Thermocouple Extension Wire, or the Panel Jack option.
CE Mark certification applies to the screw terminal version only

General Description

The DTS3250 series thermocouple acquisition system represents the next generation of Intelligent temperature scanning. This Digital Thermocouple Scanner incorporates 16 pair of thermocouple inputs, 17 22 bit A/D converters, RAM, and a micro-processor, in a rugged temperature controlled stand alone module.

An Isothermal block is incorporated for the Uniform Temperature Reference (UTR), with a $\pm 0.1^{\circ}\text{C}$ accuracy. NIST thermocouple tables for standard thermocouple types are stored in Flash Memory. The microprocessor uses these look-up tables to convert mV inputs to Engineering units. Temperature data are output in EC,EF, ER, or K .

The DTS3250 total system error is $\pm 0.5^{\circ}\text{C}$ for E, J, K, and N thermocouples, not including extension wire and external connectors, or panel jacks..

Multiple standard thermocouple types may be used with this intelligent thermocouple scanner. The DTS 3250 can accept grounded and un-grounded thermocouples.

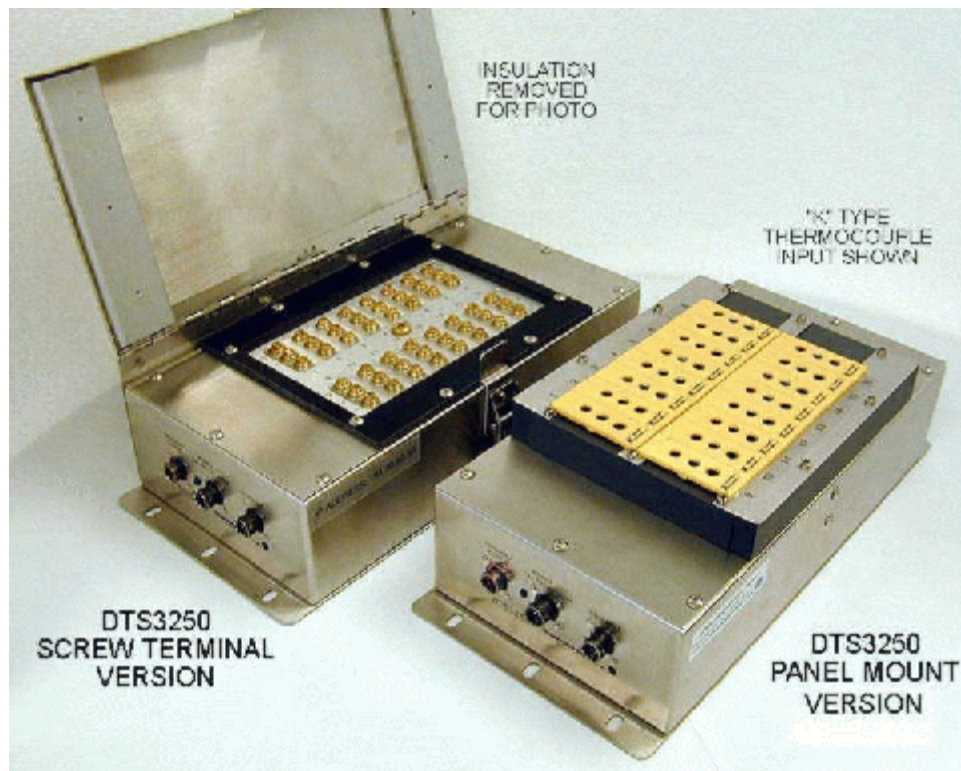

Figure 1 - DTS3250

DTS3250 Versions

Screw Terminal Version

This is the standard version of the DTS 3250. It will accept up to 16 shielded thermocouples. The top cover and insulation isolate the UTR from small temperature changes giving this unit the best accuracy. This unit also has CE Mark certification for both Heavy and Light Industrial. This version is shown on the left in Figure 1. Dimensions are shown in Figure 4.

Panel Jack Version

DTS 3250 modules may have panel jacks installed as an option. This option is available for type E, J, K, and T Thermocouples only. This option has a reduced accuracy of $\pm 2.0^{\circ}\text{C}$. CE Mark certification is not available for this configuration. A type K panel jack version is shown on the right in Figure 1. Dimensions are shown in Figure 4.

Temperature Measurement Basics

A thermocouple is a temperature sensor consisting of two leads made from different materials. The two leads are connected at one end, which is the measuring point of the thermocouple. The other end of the leads is connected to the DTS3250 cold junction(UTR).

The thermocouple output is a mV signal, typically called Electromotive Force (EMF). The EMF is a function of the difference of the dissimilar metals at the temperature source. The relation between EMF and temperature difference depends on the materials in the two thermocouple leads.

There are a number of standardized thermocouple types available on the market. Each has different properties, which makes them more or less suitable for different temperature ranges and applications.

Accuracy of a thermocouple measurement is highly dependent upon the reference junction connection, its material installation techniques, and temperature.

The DTS3250 intelligent thermocouple scanner measures the mV signal from the thermocouples and compensates for the temperature of the cold junction .

NIST ITS-90 mV-temperature tables for each type thermocouple listed in this manual are stored in the DTS3250 memory. The DTS3250 microprocessor utilizes the compensated EMF and the NIST look-up table for conversion to engineering units. Temperature data are then output via Ethernet with TCP/IP protocol.

Refer to Appendix for more information on Thermocouples.

Figure 2 below shows a function block diagram of the DTS 3250.

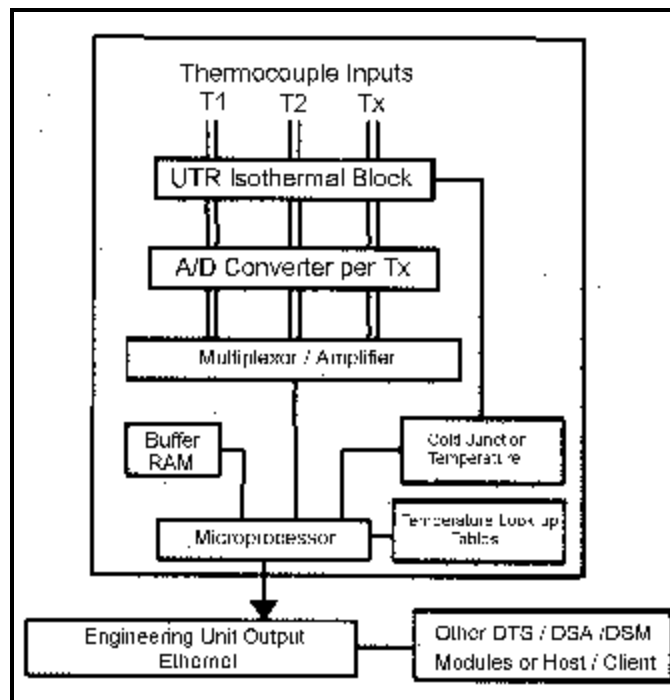

Figure 2 - DTS3250 Block Diagram

DTS Network/Firmware

DTS3250 modules accept software commands via Ethernet only. The DTS3250 modules may be controlled with an external or software scan trigger.

Each DTS module has a unique factory set 48 bit MAC address. When running TCP/IP protocol, the DTS3250 modules support ARP (Address Resolution Protocol) to enable the client/host to determine the relationship between the IP address and the Ethernet address. The IP address is user assignable.

All scan and calibration variables are configured through software by the user. This includes number of frames per scan, number of averages per frame, sampling speed, etc.

The DTS3250 firmware includes an open thermocouple test and an A/D re-zero function. The firmware contains Field calibrations which can be used to modify coefficients which can improve end to end accuracy. The RS232 communication connection may be used for firmware uploads and network configuration only. This connector also contains the external trigger input connections.

Figure 3 below shows a typical Pressure and Temperature Scanning system.

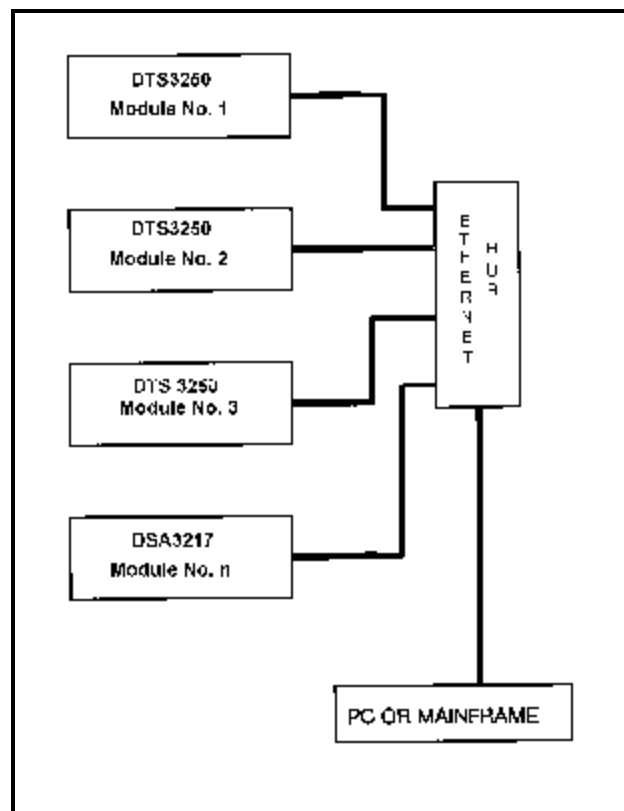
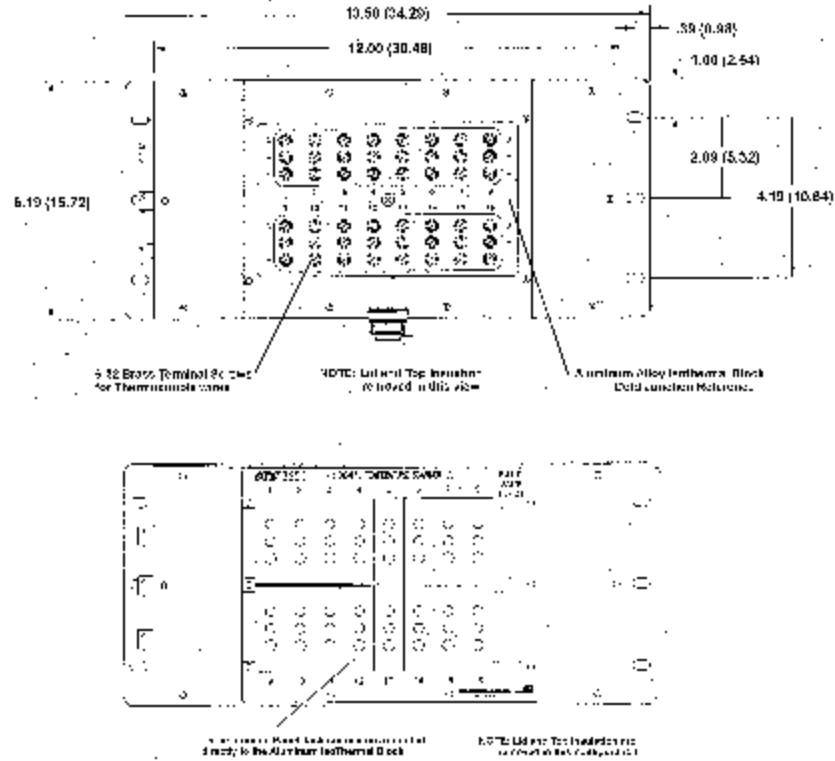

Figure 3 - Typical Pressure/Temperature Scanning System

DTS3250 Dimensions



Standard Version End View
Not Shown

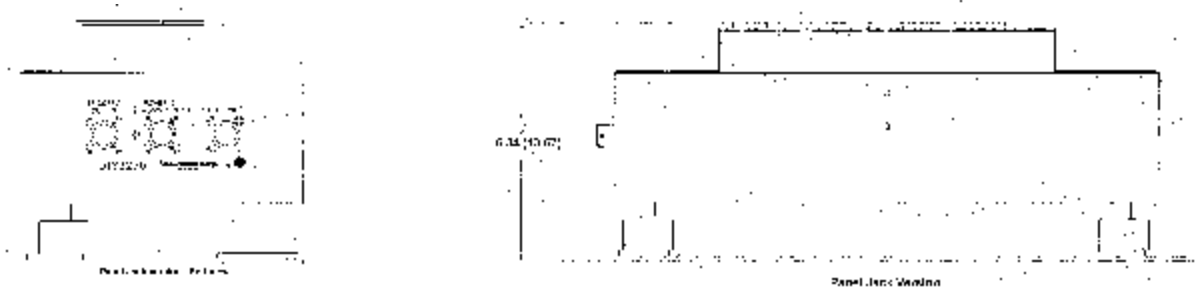
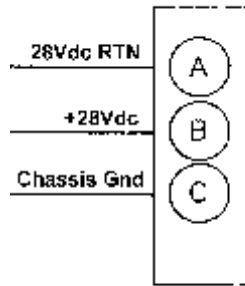

Figure 4 - DTS3250 Dimensions

Power Requirements

The DTS3250 requires $28\pm 4V_{dc}$ at approximately 70W during warmup. The power requirements will drop to approximately 14W when the module reaches the normal operating temperature. If the module is used in an environment where the ambient temperature is $10^{\circ}C$ or less, power requirements could remain high. Power connections are made through a three pin connector located on the side of the module. The pinouts of the connector may be found in figure 5. The mating connector is a PT06A-8-3S-SR.



CO-613

Figure 5 - Digital Sensor Array Power Wiring

Trigger Requirements

Hardware Trigger

The DTS3250 scan functions may be synchronized with other data acquisition devices by using the external trigger. The external trigger input is opto-isolated to prevent grounding problems. It is a TTL level, edge sensing device. It requires a minimum signal of 9Vdc @ 6.5 mA. It may accept voltages as high as 15 Vdc.

The external trigger will only be active if the DTS3250 XSCANTRIG variable is set to 1. When a SCAN command is issued by the Client/host, the module will enter the SCAN mode and wait for a trigger. An averaged frame of data will be output as soon as the minimum trigger edge level is achieved. Data will be output with each successive trigger pulse to the FPS variable (Frames per Scan) value or until a STOP command is issued.

DTS3250 Modules use a 6 pin connector for a combination Trigger and Serial Communications Interface. The wiring is shown in figure 6. The mating connector is a JT06RE8-6S-SR (Scanco Pn CO-737) .

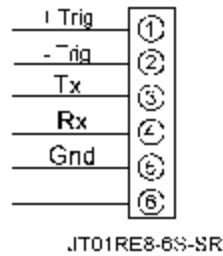

Figure 6 - Trigger wiring

Software Trigger

The DTS3250 may also be triggered with a software trigger. The software trigger will only be active if the XSCANTRIG variable is set to 1. When a SCAN command is issued by the Client/host, the module will enter the SCAN mode and wait for a trigger. An averaged frame of data will be output as soon as the TRIG command or a <TAB> character (9 HEX or Control I) is received. Data will be output with each successive trigger command to the FPS variable (Frames per Scan) value or until a STOP command is issued.

RS 232 Communications

Every DTS3250 Module has a RS 232 output. It is available at the Serial Communications/Trigger Connector. It is required to configure the module IP address, or upload operating system upgrades. The wiring of the RS 232 output is shown in figure 7.

The RS232 inputs and outputs are not opto-isolated. Therefore, the RS232 connection could cause ground loops if it is connected during data acquisitions. Because the RS232 connection is only used for initial configuration, there is no need to maintain the connection after that setup is completed unless the external trigger function will be used.

If the RS232 connection is part of a combination Serial/Trigger cable, the RS232 connection at the host computer should be disconnected during data operations to prevent problems.

A combination RS232 and External Trigger test cable(Scanco PN 155829) is available as an option. The cable is shown below along with a wiring diagram.

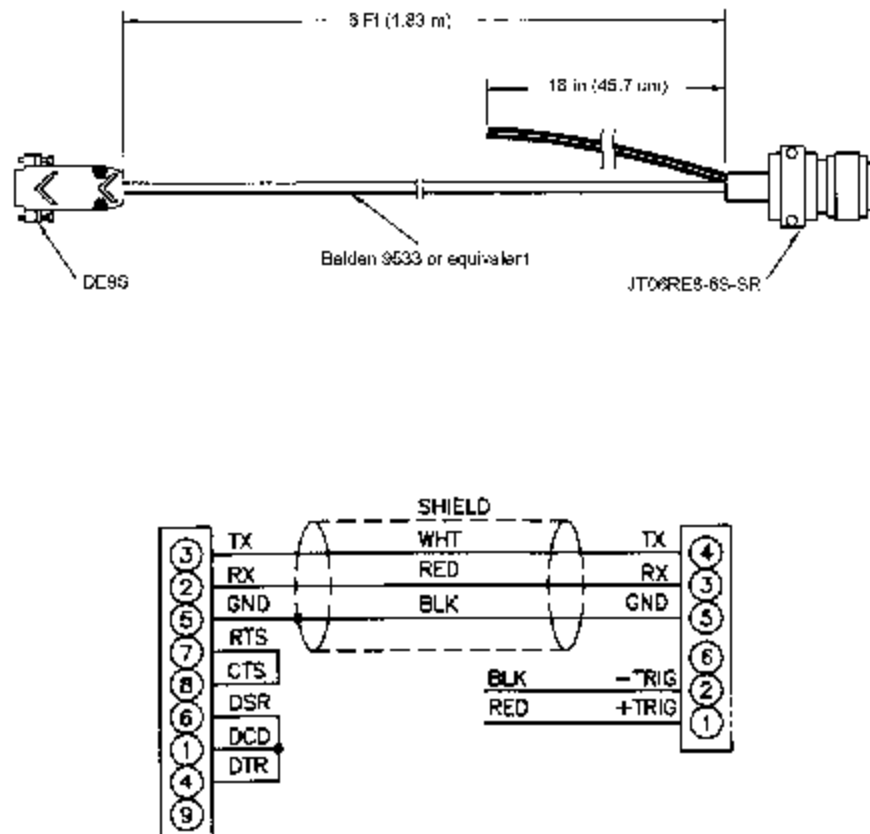

Figure 7 - RS232/ External Trigger Test Cable

ETHERNET CONNECTIONS

The DTS3250 has provisions for 10Base-T Ethernet connections only. Ethernet 10Base-2 connections may be made with media converters.

10Base-T

The 10Base-T connection uses a Bendix connector at the module, which must be interfaced to the standard RJ-45 connector. A 10Base-T connection may be straight through (pin to pin) or crossover. A straight through cable must be used if the module is connected to a hub. Crossover connections are used if the module is connected directly to the host computer. It is recommended that Category Five cables be used. The maximum length for 10Base-T cables is 100 meters, but signal strength can be attenuated at this distance. A repeater is required for 10Base-T cable runs greater than 100 meters. Cables may be ordered from Scanivalve Corp. The pin to pin cable part number is 155820-01. The crossover cable part number is 155859-01. The cable length must be specified when the cable is ordered.

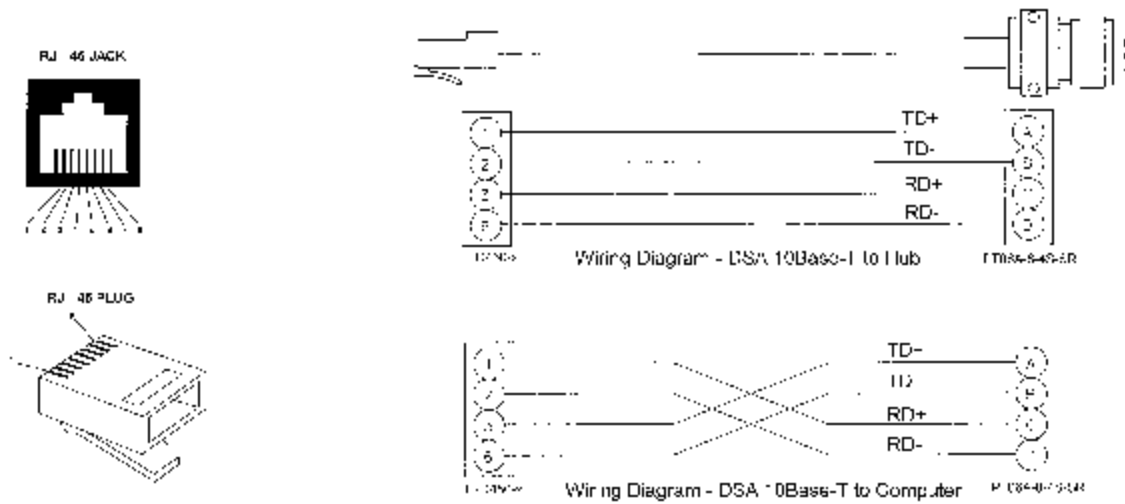

Figure 8 - DTS3250 10Base-T cables

DTS CONTROL AND CONFIGURATION

The operation of each DTS is controlled by sending ASCII commands over the TelNet port(port 23) to units selected by network addressing. The DTS returns any data or information over the network to the requesting client/host in ASCII or Binary format depending upon the settings of a configuration variable. Binary data transfers are delivered across an additional binary transfer port.

Binary transfers may be in TCP or UDP protocol. TCP requires that a Host provide a Host Binary Server program. When a DTS initiates the connection to the binary port, it can send data to the host in packet form. The port and IP address are configurable. When UDP protocol is used, no connection is required.

DTS COMMANDS

The DTS software runs as embedded software on the DTS 3250 temperature scanner hardware. It performs the following general tasks:

- 1) Read and filter the raw A/D counts that represent temperature.
- 2) Convert the A/D counts to user chosen temperature units.
- 3) Receive and execute commands from the Ethernet Link.
- 4) Allow the configuration to be saved through power down.
- 5) Output converted data, status, setup and calibration data over the Ethernet Link.
- 6) Set the DTS Physical Ethernet Address(MAC Address).
- 7) Protocol to be TCP/IP.
- 8) Support the user in troubleshooting the DTS hardware and system.

When operating in the ASCII mode or UDP, the DTS is the client. In Binary or TCP mode, the DTS is the Host.

When a DTS module is in a "NOT READY" mode, all commands are disabled except STATUS and STOP.

TCP/IP does not guarantee that packet boundaries will be maintained between a Host and a DTS module. Therefore, **ALL** commands from a Host **MUST** be terminated properly with one of four options. The DTS will detect and adjust to the termination option being used by a Host.

The four options are:

- CR (ASCII 13)
- LF (ASCII 10)
- LF-CR (ASCII 10 - ASCII 13)
- CR-LF (ASCII 13 - ASCII 10)

The current DTS RS232 interface is designed for initial boot configuration only.

COMMAND LIST

COMMAND	A/D CALIBRATION
COMMAND SYNTAX	ADCAL
ARGUMENTS	None
DESCRIPTION	Commands the DTS to calibrate the A/D converters. The A/D converters are calibrated automatically at power up and whenever the period configuration variable is set. It is possible for errors in the conversion if the temperature of the DTS has changed significantly since power up. In this case, the A/D converters can be calibrated by issuing this command.
RETURNS	<i><nb></i> <i><nb></i> - end of line.
EXAMPLE	To calibrate the A/D converters after several hours of operation, the following command would be issued: ADCAL <CR> The A/D converters will be calibrated. The time depends upon the setting of CALAVG. If CALAVG is set to 1, the time will be several seconds. If CALAVG is set to 64 this can require several minutes.
NOTE	It is recommended that a user check for A/D errors after the execution of this command. If an A/D times out or does not respond correctly, it will be disabled in software and an error will be logged. The error log is the only indication that this has occurred.
COMMAND	AUTOSTATUS
COMMAND SYNTAX	AUTOSTATUS <enable>
ARGUMENTS	Enable - 0 or 1
DESCRIPTION	If autostatus enable is set to 1, the DTS will automatically output the status of the DTS whenever the status changes. When set to 0, status can only be determined by issuing a STATUS command. The condition at power up and after a reboot is AUTOSTATUS disabled.
RETURNS	<i><nb></i> <i><nb></i> - end of line.
EXAMPLES	To enable automatic output of the DTS status, the following command would be issued: AUTOSTATUS 1 To disable automatic output of the DTS status, the following command would be issued: AUTOSTATUS 0
NOTE	AUTOTATUS was not set up as a configuration variable that could be saved to prevent conditions where the DTS would be talking on a network when it was not expected to be talking.

COMMAND	CLEAR
COMMAND SYNTAX	CLEAR
ARGUMENTS	None
DESCRIPTION	Commands the DTS to clear any errors that have occurred. The errors are sent to the client in an ASCII Packet. ASCII Packets are described in a subsequent sections.
RETURNS	<nl> <nl> - end of line.
EXAMPLE	To clear any errors listed in the ERROR Buffer, the following command would be issued: CLEAR <CR> The ERROR buffer will be cleared

COMMAND	CLOSE HOST BINARY SERVER CONNECTION
COMMAND SYNTAX	CLOBIN
ARGUMENTS	None
DESCRIPTION	Commands the DTS to close the connection to the Host Binary Server. This command will only be accepted by the DTS when the DTS is in the READY mode.
RETURNS	<nl> <nl> - end of line.
EXAMPLE	To close the connection to the Host Binary Server, the following command would be issued: CLOBIN <CR> The connection will be terminated

<p>COMMAND</p> <p>COMMAND SYNTAX</p> <p>ARGUMENTS</p> <p>DESCRIPTION</p>	<p>CONNECT TO HOST BINARY SERVER</p> <p>CONBIN</p> <p>None</p> <p>Commands the DTS to connect to the Host Binary Server configured through the HOST configuration variable. If the DTS is in the UDP mode or if a TCP connection is already established, an Error will be generated. This command will only be accepted when the DTS is in the READY mode.</p>
<p>RETURNS</p>	<p><nb></p> <p><nb> - end of line.</p>
<p>EXAMPLE 1</p>	<p>A DTS is not connected to a server, is not in the UDP mode and is in the READY mode. A CONBIN command is generated to open a connection to the Host. The following command would be issued:</p> <p style="padding-left: 40px;">CONBIN <CR></p> <p>The DTS will be connected to the Host.</p>
<p>EXAMPLE 2</p>	<p>A DTS is not connected to a server, is in the UDP mode and is in the READY mode. A CONBIN command is generated to open a connection to the Host. The following command would be issued:</p> <p style="padding-left: 40px;">CONBIN <CR></p> <p>The DTS will not connect to the Host and an Error will be generated.</p>
<p>EXAMPLE 3</p>	<p>A DTS is not connected to a server, is in the UDP mode and is in the SCAN mode. A CONBIN command is generated to open a connection to the Host. The following command would be issued:</p> <p style="padding-left: 40px;">CONBIN <CR></p> <p>The DTS will not connect to the Host and an Error will be generated.</p>

<p>COMMAND</p> <p>COMMAND SYNTAX</p> <p>ARGUMENTS</p>	<p>ENTER CHANNEL CALIBRATION SETPOINTS</p> <p>PT <index> <volts> [channel]</p> <p>Index - The setpoint number, 0 to 7 for setpoints 1 to 8.</p> <p>Volts - The applied voltage.</p> <p>Channel - Optional, If a channel is not specified, the setpoint voltage will be applied to all channels.</p>
<p>DESCRIPTION</p>	<p>This command enters the voltage correction to be applied at a given setpoint for one or more channels. The values for the setpoints do not have specific limitations.</p>
<p>EXAMPLES</p>	<p>To enter a value for setpoint 1 for all channels:</p> <p style="padding-left: 40px;">Type: PT 1 1.256<Enter></p> <p>To enter a value for setpoint 2 for channel 9:</p> <p style="padding-left: 40px;">Type: PT 2 1.744 9<Enter></p>

COMMAND
COMMAND SYNTAX
ARGUMENTS

ENTER RTD CALIBRATION SETPOINTS

RPT <index> <volts>

Index - The setpoint number, 0 to 7 for setpoints 1 to 8.

Volts - The applied voltage.

DESCRIPTION

This command enters the voltage correction to be applied at a given setpoint for the RTD's. The values for the setpoints must be between 0.095 Vdc and 0.131 Vdc which represents temperatures from -13" C to 80" C . The voltage must be inserted in the RTD1 input.

EXAMPLES

To enter a value for setpoint 1 for the RTD's:

Type: RPT 1 0.095<Enter>

To enter a value for setpoint 2 for the RTD's:

Type: RPT 2 0.998<Enter>

COMMAND
COMMAND SYNTAX
ARGUMENTS

ERROR

ERROR

None

DESCRIPTION

Lists the errors that are stored and listed after a CLEAR. Only the first 29 errors will be listed. If more than 29 errors have occurred, the message: "ERROR: Max Errors exceeded "will appear at the end of the list. An Error List may be found in Appendix D. The return format is:

ERROR: error

EXAMPLE

To read the contents of the Error Buffer:

Type: ERROR<Enter>

The DTS will return the last 29 errors in the format::

If no errors have been logged, the DTS will return:

ERROR: No errors

COMMAND
COMMAND SYNTAX
ARGUMENTS
DESCRIPTION

FILL

FILL

None

Activates the setpoint data. If Setpoints are configured, a FILL will be executed automatically at power-up. A FILL can be executed manually at any time.

EXAMPLE

To execute a FILL and activate the setpoints:

Type: FILL<CR>

COMMAND
COMMAND SYNTAX
ARGUMENTS

DESCRIPTION

RETURNS

HOST BINARY SERVER COMMAND

HOST <command>

Command - An ASCII command that would be recognized by the Host Binary Server.

This command will pass a Host Binary Server command through the DTS to the Host Binary Server

<nb>

<nb> - end of line.

COMMAND
COMMAND SYNTAX
ARGUMENTS
DESCRIPTION
EXAMPLE

LIST CALIBRATION

LIST C

None

Lists the calibration configuration variables.

To view the calibration configuration variable settings:

Type: LIST C<CR>

The DTS will return the calibration configuration variable settings. They could appear as follows.

SET NUMCOEF 3

SET NUMPTS 8

SET CALAVG 4

COMMAND
COMMAND SYNTAX
ARGUMENTS
DESCRIPTION

EXAMPLE

LIST CHANNEL CORRECTION SETPOINTS

LIST P <channel>

Channel - 0 to 16

Lists the calibration setpoints for the channel listed. If channel 0 is specified, the setpoints for all channels will be listed.

To view the calibration setpoints for channel 1:

Type: LIST P 1<CR>

The DTS returns:

SET PT 1 0 -0.010000 -275283

SET PT 1 1 0.000000 1288

SET PT 1 2 0.012000 333064

SET PT 1 3 0.024000 664759

SET PT 1 4 0.036000 996312

SET PT 1 5 0.048000 1327909

SET PT 1 6 0.060000 1659352

SET PT 1 7 0.070000 1935411

NOTE: The values shown here are values for one module. The actual calibration setpoints in a different module may be different.

COMMAND
COMMAND SYNTAX
ARGUMENTS
DESCRIPTION
EXAMPLE

LIST CONFIGURATION VARIABLES

LIST A

None

Lists all of the Configuration Variables.

To view or log the configuration variables:

Type: LISTA<CR>

The DTS will return all configuration variables

COMMAND
COMMAND SYNTAX
ARGUMENTS
DESCRIPTION

LIST GAIN

LIST G <channel>

Channel - 0 to 16

Lists the thermocouple gain correction assigned to the channel listed. If channel 0 is listed, all 16 gains will be returned.

To view the thermocouple gain settings:

Type: LIST G 0<CR>

The DTS will return all of the thermocouple gain settings. They could appear as follows.

```
SET GAIN 1 1.11
SET GAIN 2 1.01
SET GAIN 3 0.98
SET GAIN 4 1.12
SET GAIN 5 1.01
SET GAIN 6 1.15
SET GAIN 7 1.00
SET GAIN 8 1.11
SET GAIN 9 0.99
SET GAIN 10 0.98
SET GAIN 11 1.10
SET GAIN 12 1.01
SET GAIN 13 1.06
SET GAIN 14 1.00
SET GAIN 15 0.99
SET GAIN 16 1.10
```

COMMAND
COMMAND SYNTAX
ARGUMENTS
DESCRIPTION
EXAMPLE

LIST IDENTIFICATION

LIST I

None

Lists the IDENTIFICATION configuration variables.

To verify the general module configuration settings:

Type: LIST I<CR>

The DTS will return:

```
SET ECHO 0
SET SIM 0
SET AUTOCON 0
SET HOST 0 0
SET HOSTCMD SET
SET TCMAXSLEW 50000
SET RTDMAXSLEW 64000
SET TITLE1 DTS3250: Engineering Unit
SET TITLE2 Calibrated May 18, 2001
```

NOTE

A user must be very careful when modifying one of these variables. An incorrect value in one of these variables could have a detrimental affect on the operation of the module.

COMMAND
COMMAND SYNTAX
ARGUMENTS
DESCRIPTION
EXAMPLE

LIST LABELS

LIST LA

None

Lists the channel labels.

To view the channel labels:

Type: LIST LA<CR>

The DTS will return:

```
SET LABEL 1 T/C1
SET LABEL 2 T/C2
SET LABEL 3 T/C3
SET LABEL 4 T/C4
SET LABEL 5 T/C5
SET LABEL 6 T/C6
SET LABEL 7 T/C7
SET LABEL 8 T/C8
SET LABEL 9 T/C9
SET LABEL 10 T/C10
SET LABEL 11 T/C11
SET LABEL 12 T/C12
SET LABEL 13 T/C13
SET LABEL 14 T/C14
SET LABEL 15 T/C15
SET LABEL 16 T/C16
```

COMMAND
COMMAND SYNTAX
ARGUMENTS
DESCRIPTION

LIST LIMITS

LIST LI

None

Lists the channel high and low limits for alarms

EXAMPLE

To verify the channel limit settings:

Type: LIST LI<CR>

The DTS will return:

```
SET LIMIT 1 1 500.00 -50.00
SET LIMIT 2 1 500.00 -50.00
SET LIMIT 3 1 500.00 -50.00
SET LIMIT 4 1 500.00 -50.00
SET LIMIT 5 1 500.00 -50.00
SET LIMIT 6 1 500.00 -50.00
SET LIMIT 7 1 500.00 -50.00
SET LIMIT 8 1 500.00 -50.00
SET LIMIT 9 1 500.00 -50.00
SET LIMIT 10 1 500.00 -50.00
SET LIMIT 11 1 500.00 -50.00
SET LIMIT 12 1 500.00 -50.00
SET LIMIT 13 1 500.00 -50.00
SET LIMIT 14 1 500.00 -50.00
SET LIMIT 15 1 500.00 -50.00
SET LIMIT 16 1 500.00 -50.00
```

NOTE

For more information, refer to the SET LIMIT configuration variable in the LI Group.

COMMAND
COMMAND SYNTAX
ARGUMENTS
DESCRIPTION

LIST OFFSET

LIST O <channel>

Channel - 0 to 16

Lists the thermocouple offset correction assigned to the channel specified. If channel 0 is specified, all 16 offsets will be returned. The OFFSET values are A/D counts.

EXAMPLE

To view all of the thermocouple offset settings:

Type: LIST O 0<CR>

The DTS will return the thermocouple offset settings. They could appear as follows.

```
SET OFFSET 1 120
SET OFFSET 2 77
SET OFFSET 3 78
SET OFFSET 4 112
SET OFFSET 5 101
SET OFFSET 6 115
SET OFFSET 7 60
SET OFFSET 8 11
SET OFFSET 9 99
SET OFFSET 10 101
SET OFFSET 11 44
SET OFFSET 12 57
SET OFFSET 13 16
SET OFFSET 14 124
SET OFFSET 15 81
SET OFFSET 16 25
```

COMMAND
COMMAND SYNTAX
ARGUMENTS
DESCRIPTION

LIST RTD CORRECTION VALUES

LIST RP

None

Lists the RTD correction values

EXAMPLE

This command is used to verify the RTD correction values of the DTS.

Type: LIST RP<CR>

The DTS will return:

```
SET RPT 0 0.095000 1271278
SET RPT 1 0.100000 1338897
SET RPT 2 0.105000 1406643
SET RPT 3 0.110000 1474311
SET RPT 4 0.115000 1542011
SET RPT 5 0.120000 1609718
SET RPT 6 0.125000 1677418
SET RPT 7 0.131000 1758718
```

NOTE: The values shown here are values for a standard module. The actual calibration setpoints for another module may be different.

COMMAND
COMMAND SYNTAX
ARGUMENTS
DESCRIPTION

LIST RTD CONVERSION VALUES

LIST RTDP <channel>

Channel - 0 to 2

Lists the RTD conversion values for the channel specified. If 0 is entered, both RTD channel conversion values will be listed.

EXAMPLE

This command is used to verify the RTD correction values of the DTS.

Type: LIST RTDP 0<CR>

The DTS will return:

```
SET RTDP 1 0 0.00000 100.0000
SET RTDP 1 1 100.000 138.50000
SET RTDP 2 0 0.00000 100.0000
SET RTDP 2 1 100.000 138.50000
SET RTDNUMCOEF 2
SET RTDNUMPTS 2
SET RTDX1 1.000000
SET RTDX2 1.000000
```

NOTE

The values shown here are values for an ideal module. The actual calibration setpoints may be different.

COMMAND
COMMAND SYNTAX
ARGUMENTS
DESCRIPTION

LIST SCAN

LIST S

None

Lists the SCAN configuration variables

EXAMPLE

This command is used to verify the general scan settings of the DTS

Type: LIST s<CR>

The DTS will return:

```
SET PERIOD 6250
SET AVG 1
SET FPS 0
SET XSCANTRIG 0
SET FORMAT 0
SET TIME 2
SET BIN 0
SET QPKTS 0
SET UNITS C
SET RANGEV -9999.999 9999.999
SET RANGET -9999.99 9999.99
```

COMMAND
COMMAND SYNTAX
ARGUMENTS
DESCRIPTION

EXAMPLE

LIST TYPE

LIST T <channel>

None

Lists the thermocouple TYPE assigned to the channel specified. If channel 0 is specified, all channels will be listed.

To view all of the thermocouple type settings:

Type: LIST T 0<CR>

The DTS will return the thermocouple type settings. They could appear as follows.

```
SET TYPE 1 K 1
SET TYPE 2 K 1
SET TYPE 3 K 1
SET TYPE 4 N 1
SET TYPE 5 N 1
SET TYPE 6 E 0
SET TYPE 7 R 0
SET TYPE 8 R 0
SET TYPE 9 S 1
SET TYPE 10 S 1
SET TYPE 11 T 1
SET TYPE 12 T 1
SET TYPE 13 E 1
SET TYPE 14 J 1
SET TYPE 15 K 1
SET TYPE 16 E 1
```

COMMAND
COMMAND SYNTAX
ARGUMENTS
DESCRIPTION

EXAMPLE

LIST UTR CALIBRATION VARIABLES

LIST U

None

Lists the RTD calibration configuration variables

This command is used to verify the calibration configuration settings of the DTS.

Type: LIST U<CR>

The DTS will return:

```
SET RTDM1 2.599427
SET RTDM2 2.599428
SET RTDB1 -259.916748
SET RTDB2 -259.760895
SET RNUMCOEF 3
SET RNUMPTS 8
SET MAXDELTA 1.000000
SET RTDNUMCOEF 3
SET RTDNUMPTS 3
SET RTDX1 1.000000
SET RTDX2 1.000000
```

NOTE:

The values shown here are values for a standard module. The actual calibration setpoints for a different module may be different.

COMMAND
COMMAND SYNTAX
ARGUMENTS
DESCRIPTION

OPEN THERMOCOUPLE TEST

OTC

None

Commands the DTS to test for open thermocouples. The command causes a small current to be applied to each thermocouple. If a thermocouple is found to be open, an error is logged and bit 12 in the channel status element of the data packet is set to a 1 (1000Hex). Also, the channel status code for an open channel will be 2000 if scanning with FORMAT set to 0. This command is NOT performed automatically at power up.

RETURNS

<nl>

<nl> - end of line.

EXAMPLE

To test for open thermocouples, the following command would be issued:

OTC<CR>

COMMAND
COMMAND SYNTAX
ARGUMENTS
DESCRIPTION

REBOOT

REBOOT

None

Commands the DTS to reboot. Any coefficients and configuration variables that have not been saved will be reset to the last saved values.

RETURNS

<nl>

<nl> - End of line.

EXAMPLE

To reboot from the network,

Type: REBOOT<CR>

COMMAND
COMMAND SYNTAX
ARGUMENTS
DESCRIPTION

SAVE

SAVE

None

Commands the DTS to save the RAM image of Non Volatile Memory(NVM). Any change to a configuration variable must be followed by a SAVE command if the change is to be permanent.

RETURNS

<nl>

<nl> - End of line.

EXAMPLE

To save the current configuration variable settings and conversion coefficients,

Type: SAVE<CR>

COMMAND
 COMMAND SYNTAX
 ARGUMENTS
 RETURNS

SCAN

SCAN

None

Scan data formatted by the setting of EU, BIN, and FORMAT. Refer to the examples for more information. When FORMAT is set to 0, a channel status code will be returned with the data for each channel. If multiple errors exist the code with the highest priority will be the only code displayed

Status Code	Description	Priority
1000	Channel A/D is disabled	1
2000	Channel T/C is open	2
3000	Channel is over range	3
4000	Channel is under range	4
5000	Channel is over limit	5
6000	Channel is under limit	6

DESCRIPTION

Commands the DTS to scan the pressure sensors and send Scan packets to the client. Data are returned immediately if XSCANTRIG is set to 0. If XSCANTRIG is set to 1, data will be returned after a hardware trigger, or a software trigger. For more information on software triggers, refer to the SCAN TRIGGER command. For Hardware trigger requirements, refer to the Trigger Requirements section.

EXAMPLE 1

EU = 1
 BIN = 0
 FORMAT= 0.

Data are scrolled and will be displayed as follows:

```

Frame # <number>
Time <time> <Fs or ms>
Rtd1 <temp>
Rtd2 <temp>
Units <unit>
<chan 1> <temp eu> <channel status code>
" "
" "
<chan 16> <temp eu> <channel status code>
  
```

EXAMPLE 2

EU = 0
 BIN = 0
 FORMAT= 0

Data are scrolled and will be displayed as follows:

```

Frame # <number>
Time <time> <Fs or ms>
Rtd1 <temp counts>
Rtd2 <temp counts>
Units <unit>
<chan 1> <temp counts> <channel status code>
" "
" "
<chan 16> <temp counts> <channel status code>
  
```

EXAMPLE 3

```

EU = 1
BIN = 0
FORMAT = 1
Data are scrolled in place and will be displayed as follows:
Frame = <number> Time = <time> <Fs or ms> Units = <unit>
<chan> <temp eu> <chan><temp eu> <chan> <temp eu> <chan> <temp eu>
<chan> <temp eu> <chan><temp eu> <chan> <temp eu> <chan> <temp eu>
<chan> <temp eu> <chan><temp eu> <chan> <temp eu> <chan> <temp eu>
<chan> <temp eu> <chan><temp eu> <chan> <temp eu> <chan> <temp eu>

```

EXAMPLE 4

```

EU = 1
BIN = 0
FORMAT = 1
Data are scrolled and will be displayed as follows:
Frame = <number> Time = <time> <Fs or ms> Units = <unit>
<chan> <temp cts> <chan><temp cts> <chan> <temp cts> <chan> <temp cts>
<chan> <temp cts> <chan><temp cts> <chan> <temp cts> <chan> <temp cts>
<chan> <temp cts> <chan><temp cts> <chan> <temp cts> <chan> <temp cts>
<chan> <temp cts> <chan><temp cts> <chan> <temp cts> <chan> <temp cts>

```

COMMAND
COMMAND SYNTAX
ARGUMENTS
DESCRIPTION

SCAN TRIGGER
TRIG

None

This command acts as a software trigger to the DTS. When XSCANTRIG is set to 1, an averaged frame of data will be output when the DTS receives the TRIG command or a <TAB> character code (9 HEX or Control I). This will continue until a STOP command is issued or the Frames per Scan variable is met. The data format will depend upon the setting of EU, BIN and FORMAT.

EXAMPLE 1

A scan command is executed with EU set to 1, BIN set to 0, XSCANTRIG set to 1, and FORMAT set to 0. The DTS will wait for a Hardware trigger, the TRIG command or a <TAB> character (9 HEX or Control I). When one of the Data are scrolled and will be displayed as follows:

```

Frame # <number>
Time <time> <Fs or ms>
<chan> <temp eu>
"      "
"      "
<chan> <temp eu>

```

For information on other formats, refer to the SCAN command .

COMMAND
COMMAND SYNTAX
ARGUMENTS

SET

SET <name> <value>

<name> - the Configuration Variable to be set or modified.

<value> - the value of that Configuration Variable

DESCRIPTION

Commands the DTS to set one of the many Configuration Variables. Configuration Variables are described in a subsequent section.

NOTE

Listing the Configuration Variables with the LIST command outputs the data in the format required by the SET command. This enables the user to upload data from a file that has been created by a LIST download.

COMMAND
COMMAND SYNTAX
ARGUMENTS
DESCRIPTION

STATUS

STATUS

None

Commands the DTS to send a Status Packet to the client. The Status Packet is described in a subsequent section.

The STATUS command may be entered at any time. This is one of the commands that will not generate an error if entered while the DTS is not READY. The DSM could return one of the following status descriptions

ADCAL	The DTS is calibrating the A/D converters
CAL	The DTS is executing a PT or RPT command
INVALID	The DTS is in an INVALID operating mode.
LIST	The DTS is outputting a configuration variable LIST
OTC	The DTS is testing for open thermocouples
READY	The DTS is operating and ready to accept a command.
SAVE	The DTS is SAVING a configuration
SCAN	The DTS is in the SCAN mode.
TYPE	The DTS is setting the thermocouple type
UPLOAD	The DTS is UPLOADING a file.

EXAMPLES

If the STATUS command is entered while the DTS is on, but inactive, the DSM will return:

Status: READY

If the STATUS command is entered while the DSM is executing a SAVE command, the DSM will return:

Status: SAVE

COMMAND
COMMAND SYNTAX
ARGUMENTS
DESCRIPTION
RETURNS

STOP
STOP
None
Commands the DTS to abort the current operation.
<nb>
<nb> - end of line.

EXAMPLE

To abort any function or operation:
Type: STOP<CR>

COMMAND
COMMAND SYNTAX
ARGUMENTS

UPLOAD
UPLOAD <S or C><filepath\filename>
S System file to be uploaded
C Configuration file to be uploaded

DESCRIPTION

Uploads the specified file to the DTS module. The DTS interprets the type of file based on the file type argument.

RETURNS

<nb>
<nb> - end of line.

EXAMPLE

To upload the configuration variable file cv.cfg, located in the DTS files subdirectory on drive c: of the host computer:
Type: UPLOAD C c:\DTSfiles\cv.cfg

This file will be downloaded from the machine defined by the configuration port settings. The term "host" might be more accurately described as an "FTP Server". This could be the same computer as the host or a different computer somewhere on a network. The relevant settings are:

Host Name
Host INET
User
FTP Password

NOTE

S or C must be uppercase
Refer to the DTS3200 Boot Parameter Modification and DTS Operating System Upload Procedures for more information.

COMMAND
COMMAND SYNTAX
ARGUMENTS
DESCRIPTION
RETURNS

VERSION
VER
None
Outputs the current software version number.
DTSHS Scanivalve © 2000 Ver x.xx y
x.xx is the software version number.
y is the hardware version number

EXAMPLE

To read the current software version:
Type: VER<CR>
The DTS returns:
Version: DTSHS Scanivalve © 2001 Ver 2.01 3

CONFIGURATION VARIABLES

Configuration Variables control the way the DTS functions. The Variables are assigned to one of several groups: SCAN(S), IDENTIFICATION(I), CALIBRATION(C), CHANNEL CORRECTION(P), GAIN(G), OFFSET(O), LABELS(LA), LIMIT(LI), THERMOCOUPLE(T), RTD CORRECTION(RP), RTD CONVERSION(RTDP), and RTD CALIBRATION(U). Each variable is assigned a "data type" description.

SCAN VARIABLES (Group S)

VARIABLE	AVG <value>
VALID VALUES	1 to 240
DEFAULT VALUE	4
DATA TYPE	integer
DESCRIPTION	This sets the number of raw samples to acquire before producing a filtered output.

VARIABLE	BIN <code>
VALID VALUES	1 or 0
DEFAULT VALUE	0
DATA TYPE	integer
DESCRIPTION	Sets the format of the data packet output. 1 = Binary 0 = ASCII

VARIABLE	FORMAT <code>
VALID VALUES	0, or 1
DEFAULT VALUE	1
DATA TYPE	Integer
DESCRIPTION	Determines if data are to be scrolled on the display. ASCII Output only 0 - data are scrolled 1 - data are displayed in place, formatted for a VT100 terminal.

VARIABLE	FPS <value>
VALID VALUES	0 to 2147483648
DEFAULT VALUE	0
DATA TYPE	long integer
DESCRIPTION	Sets the number of averaged frames to send to the client. If a 0 is entered, the scan will continue until a STOP command is received.

VARIABLE **PERIOD <value>**
 VALID VALUES 1563 to 31996 Fsec
 DEFAULT VALUE 6250
 DATA TYPE integer
 DESCRIPTION Sets the interval between channel samples.
 NOTE Periods faster than 6250 microseconds will result in a greater measurement uncertainty. Instrument accuracies listed in the specifications are based on periods of 6250 microseconds or slower.

VARIABLE **QPKTS <code>**
 VALID VALUES 0 or 1
 DEFAULT VALUE 1
 DATA TYPE integer
 DESCRIPTION This switch will control the action the DTS will take when the data buffer is full.
 0 - frames will be discarded when the data buffer is full. The DTS will continue to scan.
 1 - no frames will be lost. The DTS will stop scanning and log an error if the data buffer is filled.

VARIABLE **RANGET <low range temp value> <high range temp value>**
 VALID VALUES -9999.99 to 9999.99
 DEFAULT VALUE Low range temp value - -9999.99
 High range temp value - 9999.99
 DATA TYPE Integer
 DESCRIPTION Sets the output when units is set to a temperature and the high and/or low range limits are exceeded. When a channel exceeds the low limit, the data display will be setting of the low range value and the channel status code will indicate 4000. When the high limit is exceeded, the data display will be setting of the high range value and the channel status code will indicate 3000.

VARIABLE **RANGEV <low range volt value> <high range volt value>**
 VALID VALUES -9999.99 to 9999.99
 DEFAULT VALUE Low range volt value - -9999.99
 High range volt value - 9999.99
 DATA TYPE Integer
 DESCRIPTION Sets the output when units is set to volts and the high and/or low range limits are exceeded. When a channel exceeds the low limit, the data display will be setting of the low range value and the channel status code will indicate 4000. When the high limit is exceeded, the data display will be setting of the high range value and the channel status code will indicate 3000.

VARIABLE	TIME <code>
VALID VALUES	0, 1, or 2
DEFAULT VALUE	0
DATA TYPE	Integer
DESCRIPTION	Determines the format of the Time Stamp. 0 - No Time Stamp 1 - Time stamp data are in microseconds 2 - Time stamp data are in milliseconds

VARIABLE	UNITS <type>
VALID VALUES	see list below
DEFAULT VALUE	C
DATA TYPE	string
DESCRIPTION	Engineering Unit conversion type. This can be : A - Volts(Vdc) corrected by the RTD voltage C - degrees Celsius(EC) F - degrees Fahrenheit(EF), K - Kelvin(K) R - degrees Rankin(ER) V - Volts(Vdc) Raw uncorrected 0 - Zero(Raw Counts)

VARIABLE	XSCANTRIG <code>
VALID VALUES	0 or 1
DEFAULT VALUE	0
DATA TYPE	integer
DESCRIPTION	Sets the External Trigger as the Frame Trigger. 0 = the internal clock is the frame trigger 1 = the external trigger is the frame trigger

CHANNEL CORRECTION VARIABLES (Group P)

VARIABLE	PT <channel> <index> <volts applied> <counts applied>
VALID VALUES	Channel - 1 to 16 for channels 1 to 16 Index - 0 to 7 Volts Applied - any valid number Counts Applied - any valid number
DEFAULT VALUE	Channel - 1 to 16 Index - 0 Volts Applied - 0 Counts Applied - 0
DATA TYPE	Channel - Integer Index - Integer Volts Applied - float Counts Applied - Integer
DESCRIPTION	This is the list of setpoints used to calibrate each channel.
EXAMPLE	The List P command is used to view these variables. The variables for each channel are set before the initial factory calibration. To list the values for channel 2, Type: LIST P 2<Enter> The DTS will return: SET PT 2 0 -0.010000 -276468 SET PT 2 1 0.000000 517 SET PT 2 2 0.012000 332795 SET PT 2 3 0.024000 664988 SET PT 2 4 0.036000 997039 SET PT 2 5 0.048000 1329141 SET PT 2 6 0.060000 1661087 SET PT 2 7 0.070000 1937569
NOTE	The values shown here are values for a standard module. The actual calibration setpoints may be different.

IDENTIFICATION VARIABLES (Group I)

<p>VARIABLE VALID VALUES DEFAULT VALUE DATA TYPE DESCRIPTION</p>	<p>AUTOCON <code> 0 or 1 0 integer Determines if the DTS will automatically convert to a binary receiver. 0 - the DTS will not automatically convert. 1 - the DTS will automatically convert.</p>
--	--

<p>VARIABLE VALID VALUES DEFAULT VALUE DATA TYPE DESCRIPTION</p>	<p>SIM <code> 0, or 1 0 Integer Determines the source of the data samples. 0 - Data are taken from the sensors 1 - Data are generated internally</p>
--	---

<p>VARIABLE VALID VALUES DEFAULT VALUE DATA TYPE DESCRIPTION</p>	<p>ECHO <code> 0 or 1 0 integer Determines if characters received from an ethernet host will be echoed back to the host. 0 - the DTS will not echo characters 1 - the DTS will echo characters back to the host.</p>
--	---

<p>VARIABLE VALID VALUES DEFAULT VALUE DATA TYPE DESCRIPTION</p>	<p>HOST <IP address> <port> Any valid IP address Any valid Port IP Address - 0 Port - 0 varies Sets the value of the IP address and port number for binary data for the host computer. If IP Address and Port are set to 0, Binary data are sent out over the TelNet Port. If a server address and port number are defined, Binary data are sent out over that port.</p>
--	---

<p>VARIABLE VALID VALUES DEFAULT VALUE DATA TYPE DESCRIPTION</p>	<p>HOSTCMD <ASCII string> any valid host command 0 ASCII Strings Sends the ASCII command string contained in this variable to the host computer binary receiver.</p>
--	---

VARIABLE	RTDMAXSLEW <value>
VALID VALUES	0 to 32000
DEFAULT VALUE	16000
DATA TYPE	Integer
DESCRIPTION	This is the maximum allowable step change in counts per second for an RTD input. If the step change exceeds this value, the DTS will output the last value before the step. If the DTS stays out of range for 5 samples, then the new range will be considered to be the new value.
NOTE	This feature is only functional in hardware version 1. The hardware version is reported with the software version when a VER command is executed.

VARIABLE	TCMAXSLEW <value>
VALID VALUES	0 to 100000
DEFAULT VALUE	50000
DATA TYPE	Integer
DESCRIPTION	This is the maximum allowable step change in counts per second for a thermocouple input. If the step change exceeds this value, the DTS will output the last value before the step. If the DTS stays out of range for 5 samples, then the new range will be considered to be the new value.
NOTE	This feature is only functional in hardware version 1. The hardware version is reported with the software version when a VER command is executed.

VARIABLE	TITLE1 <title>
VALID VALUES	any valid ASCII string up to 255 characters
DEFAULT VALUE	Scanivalve DTS3250
DATA TYPE	ASCII String
DESCRIPTION	Sets the value of Title number 1.

VARIABLE	TITLE2 <title>
VALID VALUES	any valid ASCII string up to 255 characters
DEFAULT VALUE	The current software version.
DATA TYPE	ASCII String
DESCRIPTION	Sets the value of Title number 2.

CALIBRATION VARIABLES (Group C)

VARIABLE	CALAVG <value>
VALID VALUES	1 to 64
DEFAULT VALUE	4
DATA TYPE	integer
DESCRIPTION	Determines how much averaging to perform during an A/D Calibration. This setting will have an effect on boot up time.

VARIABLE	NUMPTS <points>
VALID VALUES	1 to 8
DEFAULT VALUE	8
DATA TYPE	integer
DESCRIPTION	Determines the number of setpoints in the channel correction list.

VARIABLE	NUMCOEF <coef>
VALID VALUES	1 to 3
DEFAULT VALUE	3
DATA TYPE	integer
DESCRIPTION	Determines the number of calibration coefficients for the channel corrections. 1 - Offset only 2 - $y = mx + b$ correction curve 3 - $y = ax^2 + bx + c$ correction curve

LIMIT VARIABLES (Group LI)

VARIABLE	LIMIT <channel> <enable> [<high limit> low limit>]
VALID VALUES	Channel - 0 to 16, if 0 is entered all channels will be set. Enable - 0 disables limits 1 enables limits High limit - optional, the high limit value Low limit - optional, the low limit value
DEFAULT VALUE	Channel - 0 Enable - 0 High limit - 100 Low limit - 0
DATA TYPE	Integer
DESCRIPTION	Sets the high and low limits for each channel. When a channel exceeds the low limit, the channel status code will indicate 6000. When the high limit is exceeded, the channel status code will indicate 5000.

CHANNEL LABELS (Group LA)

VARIABLE	LABEL <channel> <label>
VALID VALUES	Channel- 1 to 16 Label - channel label up to 31 characters. Spaces are allowed.
DEFAULT VALUE	Channel - 0 Label - T/C <channel>
DATA TYPE	Channel- Integer Label - ASCII string
DESCRIPTION	Sets the label for each channel..

THERMOCOUPLE VARIABLES (Group T)

VARIABLE	TYPE <channel> <type> [shield connect]
VALID VALUES	channel - the channel number, 0 through 16 type - E, J, K, N, R, S, or T
DEFAULT VALUE	channel - 0 type - J shield connect - 1
DATA TYPE	integer
DESCRIPTION	Determines the thermocouple conversion for each channel. If the channel is entered as 0, all 16 channels will be set to the thermocouple type specified. The shield connection switch should be set based on the method used to ground or shield the thermocouple. If shield connect is set to 0, the switch will be open. The default setting is 1 or closed. Refer to the figures below for more information on how to properly define this parameter.

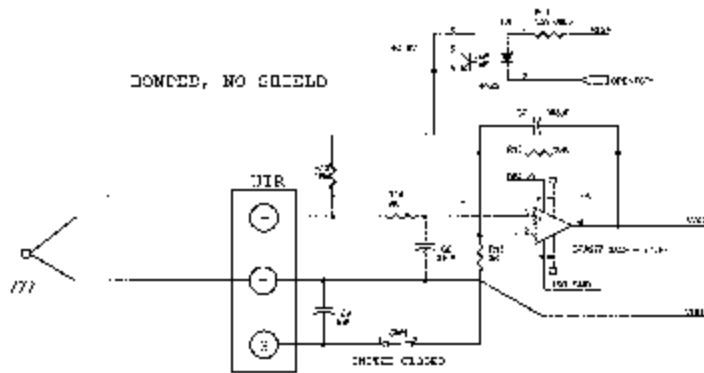

Figure 9 - Bonded Thermocouple, No Shield

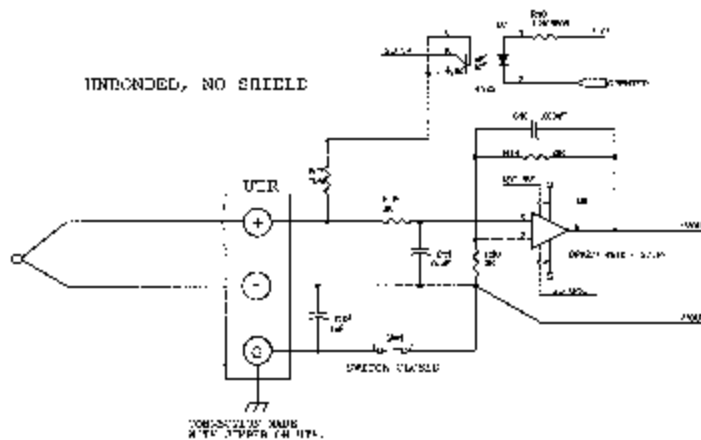

Figure 10 - Unbonded Thermocouple, No Shield

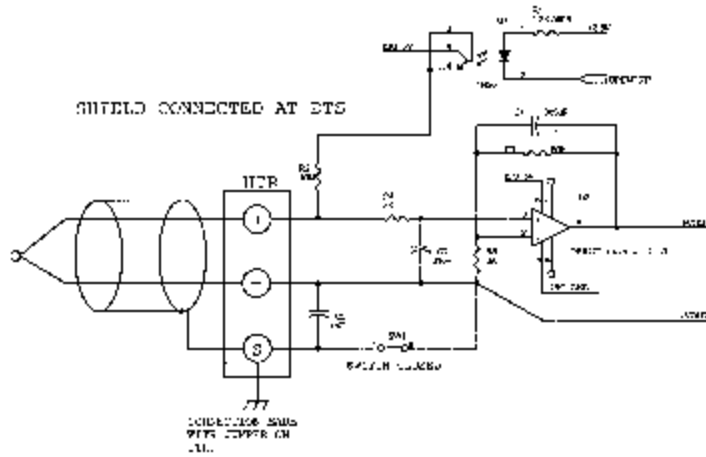

Figure 11 - Shielded Thermocouple, Shield connected at the DTS

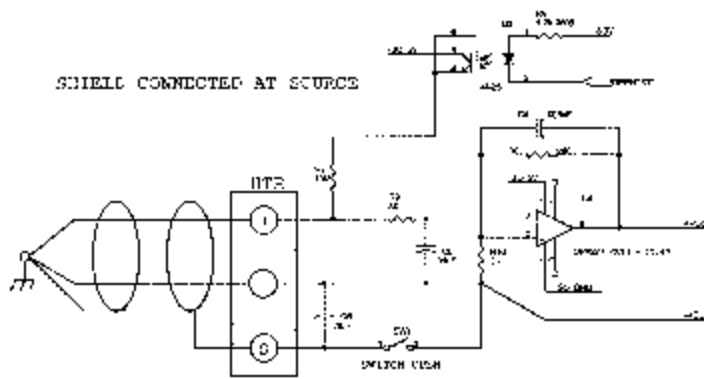

Figure 12 - Shielded Thermocouple, Shield connected at the source

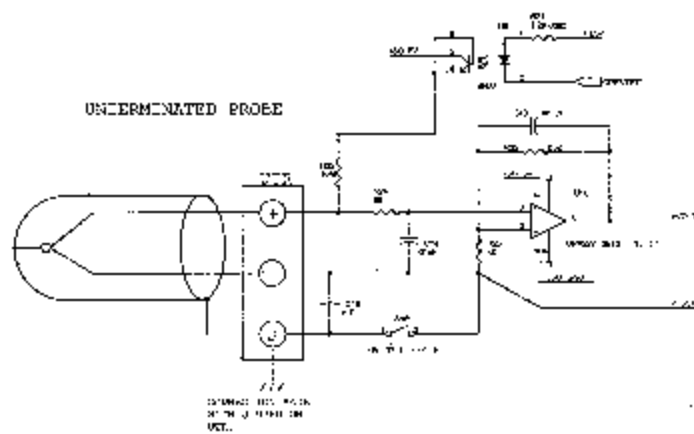

Figure 13 - Unterminated Probe

RTD CORRECTION VARIABLES (Group RP)

VARIABLE	RPT <index> <volts applied> <counts applied>
VALID VALUES	Index - 0 to 7 Volts Applied - any valid number Counts Applied - any valid number
DEFAULT VALUE	Index - 0 Volts Applied - 0 Counts Applied - 0
DATA TYPE	Index - Integer Volts Applied - float Counts Applied - Integer
DESCRIPTION	This is the list of setpoints used to calibrate the RTD's. Both RTD's are corrected by the same setpoints.
EXAMPLE	The List RP command is used to view these variables. The variables are set to the following before the initial factory calibration: SET RPT 0 0.095000 1287022 SET RPT 1 0.105000 1557974 SET RPT 2 0.131000 1774736
NOTE	The values shown here are values for an ideal module. The actual calibration setpoints may be different.

RTD CONVERSION VARIABLES (Group RTDP)

VARIABLE	RTDP <channel> <index> <temp> <ohms>
VALID VALUES	Channel- 1 and 2 Index - 0 to 7 Temp - the temperature in degrees C at the ohms value Ohms - The resistance of the RTD at the indicated temp
DEFAULT VALUE	Channel- 0 and 1 Index - 0 and 1 Temp - 0 and 100 Ohms - 100 and 138.5
DATA TYPE	Channel- Integer Index - Integer Temp - float Ohms - float
DESCRIPTION	This is the list of conversion variables used to convert the resistance of each RTD to degrees C. Both RTD's are corrected by the same number of setpoints and by the same conversion type.
EXAMPLE	The List RTDP command is used to view these variables.
NOTE	When all RTDP setpoints have been entered, a FILL command must be issued to generate RTDM1, RTDM2, RTDB1, AND RTDB2

VARIABLE	RTDNUMPT <points>
VALID VALUES	0 to 8
DEFAULT VALUE	2
DATA TYPE	integer
DESCRIPTION	Determines the number of setpoints in the RTD conversion calculation. If this variable is set to 0, The RTDP variables will not be used. RTDM1, RTDM2, RTDB1, and RTDB2 will be used instead.

VARIABLE	RTDNUMCOEF <coef>
VALID VALUES	1, 2, or 3
DEFAULT VALUE	2
DATA TYPE	integer
DESCRIPTION	Determines the type of conversion calculation to be used. Currently only a slope-intercept conversion is enabled. <ul style="list-style-type: none"> 1 - Van Dusen Equation 2 - Van Dusen Equation 3 - $y = ax^2 + bx + c$

VARIABLE	RTDX1 <value>
VALID VALUES	any real number
DEFAULT VALUE	1.00000
DATA TYPE	float
DESCRIPTION	The conversion factor for RTD1 to convert ohms to millivolts for temperature conversion.

VARIABLE	RTDX2 <value>
VALID VALUES	any real number
DEFAULT VALUE	1.00000
DATA TYPE	float
DESCRIPTION	The conversion factor for RTD2 to convert ohms to millivolts for temperature conversion.

CHANNEL GAIN CORRECTION VARIABLES (Group G)

VARIABLE	GAIN <channel> <gain value>
VALID VALUES	any real number
DEFAULT VALUE	1
DATA TYPE	float
DESCRIPTION	Sets the GAIN correction for a given channel using the formula:

$$\text{Adjusted Counts} = (\text{GAIN} * \text{counts}) + \text{OFFSET}.$$

CHANNEL OFFSET CORRECTION VARIABLES (Group O)

VARIABLE	OFFSET <channel> <gain value>
VALID VALUES	any real number
DEFAULT VALUE	0
DATA TYPE	float
DESCRIPTION	Sets the OFFSET correction for a given channel using the formula:

$$\text{Adjusted Counts} = (\text{GAIN} * \text{counts}) + \text{OFFSET}.$$

RTD CALIBRATION VARIABLES (Group U)

VARIABLE	MAXDELTA <value>
VALID VALUES	any real number
DEFAULT VALUE	.25
DATA TYPE	Integer
DESCRIPTION	This is the maximum allowable difference between the readings of RDT1 and RTD2 in degrees C. If MAXDELTA exceeds this setpoint, an error is logged and bit 12 is set in the general status element of the data packet.

VARIABLE	RNUMPTS <points>
VALID VALUES	1 to 8
DEFAULT VALUE	3
DATA TYPE	integer
DESCRIPTION	Determines the number of setpoints in the RTD correction list.

VARIABLE	RNUMCOEF <coef>
VALID VALUES	1 to 3
DEFAULT VALUE	3
DATA TYPE	integer
DESCRIPTION	Determines the number of calibration coefficients in the RTD correction list. 1 - Offset only 2 - $y = mx + b$ correction curve 3 - $y = ax^2 + bx + c$ correction curve

VARIABLE	RTDB1 <value>
VALID VALUES	any real number
DEFAULT VALUE	-259.7403
DATA TYPE	float
DESCRIPTION	The "B" term in the conversion equation used to convert RTD #1 millivolts to degrees Celsius. The conversion formula is:

$$EC' \text{ millivolts} (rtdM\%rtdB$$

VARIABLE	RTDB2 <value>
VALID VALUES	any real number
DEFAULT VALUE	-259.7403
DATA TYPE	float
DESCRIPTION	The "B" term in the conversion equation used to convert RTD #2 millivolts to degrees Celsius. The conversion formula is:

$$EC' \text{ millivolts} (rtdM\%rtdB$$

VARIABLE	RTDM1 <value>
VALID VALUES	any real number
DEFAULT VALUE	2.59703
DATA TYPE	float
DESCRIPTION	The "M" term in the conversion equation used to convert RTD #1 millivolts to degrees Celsius. The conversion formula is:

$$EC' \text{ millivolts} (rtdM\%rtdB$$

VARIABLE	RTDM2 <value>
VALID VALUES	any real number
DEFAULT VALUE	2.597403
DATA TYPE	float
DESCRIPTION	The "M" term in the conversion equation used to convert RTD #2 millivolts to degrees Celsius. The conversion formula is:

$$EC' \text{ millivolts} (rtdM\%rtdB$$

DTS Packet Definitions

When requested the DTS sends an application packet to the client. Each packet sent to the client starts with a Packet Type Word. This word defines the packet type.

Packet Type Table

PACKET NAME	PACKET ID	BYTES	NOTES
Data	0Hex	168	
Host Control	1Hex	168	
Scan Raw	4Hex	70	Transmits Temperature data in binary, raw counts.
Scan EU	5Hex	104	Transmits Temperature data in binary, engineering units.
Scan Raw -Time	6Hex	38	Transmits Temperature data in binary, raw counts with a time stamp.
Scan EU - Time	7Hex	72	Transmits Temperature data in binary, engineering units with a time stamp.
ASCII	20Hex	Variable	Text Packet may be formatted or un-formatted. The format is determined by the setting of the FORMAT Configuration Variable. NOTE: When the first integer of the packet is 20Hex or greater, the packet is assumed to be in ASCII FORMAT.

Host Control Packet: Type 1

Command Packet

FUNCTION DESCRIPTION	BYTES	DESCRIPTION
Packet Type	4	0 = Data Packet, 1 = Host Control
Host ASCII Command Data (Refer to the Command Section of this manual for more information)	164	ASCII string received by DTS as the Host command. Each line must be terminated with a CR, LF, CR-LF or LF-CR.

DTS to HOST Binary Data Packet

FUNCTION	BYTES	DATA TYPE	DESCRIPTION
Packet Type	4	Integer	0Hex
General Status	4	Integer	Bit 12 is set if errors exist
Frame Number	4	Integer	The current frame number if in the scan mode
Temperature 1 to 16	64	Float	Channel temperatures in units set by bits 4 - 6 of the General Status Bytes.
RTD1 Temperature	4	Float	RTD1 temperature in Raw counts or degrees Celsius.
RTD2 Temperature	4	Float	RTD2 temperature in Raw counts or degrees Celsius.
Time Stamp	4	Float	Time in units set by bit 8 of the General Status Bytes.
Channel Status 1 to 16	64	Integer	Bits 0 - 4: Thermocouple Type Bits 5 - 15: Error Codes Bits 16 - 31: Not Used
Spares	16	Integer	Spares

ASCII Packet

This packet will be transmitted when the host issues one of the following commands:

- 1) SCAN with BIN set to 0
- 2) LIST n
- 3) ERROR
- 4) STATUS

FUNCTION DESCRIPTION	BYTES	DATA TYPE	VALUE
ASCII Data (The first two bytes must NOT be 1Hex through 1FHex). Refer to the Command Section of this manual for the proper Command return formats.	1 to 1492	String	Unique to Packet. Each line is terminated with a CR, LF, CR-LF, or LF-CR.

Network Protocols Supported

Physical Layer : 10Base-T IEEE 802.3
Link Layer: INTERNET Protocol (IP)
Transport Layer: Transmission Control Protocol (TCP)
 User Datagram Protocol (UDP)

DTS3250 Recommended Operation

1. Energize the unit and allow 3 hours for warm-up.
2. While the unit is warming up, connect the thermocouples to the inputs.
3. Verify that the thermocouple types are set correctly. The following command should be used:
 List T 0 All channels will be listed. The thermocouple type will be shown as well as the shield connection. Refer to the figures in Thermocouple variable group section for more information.
4. Enter labels for the thermocouples, if desired. The current label entries may be viewed by the following command:
 List LA Labels may be changed by using the SET LABEL x function where x is the channel number.
5. Enter channel range limits. This is the number that will be displayed if the input exceeds the calibrated range of the unit. Refer to RANGEV and RANGET variables for more information.
6. Enter channel limits. These are the temperature limits that will be used for alarm outputs. The current channel limits may be viewed by typing:
 List LI
7. Verify the SCAN variable settings. Type:
 List S The scan variables will be listed
8. When the unit has completed the warmup, Issue the following commands:
 ADCAL Re-zero the A/D converters
 OTC Test for open thermocouples
 ERROR Check for errors
9. If no errors are logged, the unit is ready for test.
10. It is also recommended that the user check for errors every time the ADCAL command is executed. If an A/D times out or does not respond correctly during the execution of that command, the A/D will be disabled in software. The only indication that this has occurred will be an error logged in the error buffer.

Special Operational Notes

1. If any RTD reading is outside the range -10.0 °C to 70.0 °C, the last good reading is used. NO error will be logged.
2. If any thermocouple reading is outside the range -200.0 °C to 1800 °C, the last good reading is used. NO error will be logged.
3. If any A/D converters are disabled due to errors, an error will be logged and bit 12 of the channel status element in the data packet will be set.

DTS Web Server

Software versions 2.04 and higher have a built in web server program. Version 2.04 will only operate with Netscape Navigator Version 4.74 or higher. Versions 2.05 and higher will operate with Netscape Navigator or Microsoft Internet Explorer.

The purpose of the Web Server is to provide a means of communication between DTS Modules and a PC. It is designed to give a user the tools necessary to be able to interface to a DTS Module. It is not intended to be an application software. It operates in Microsoft Windows 95/98/NT/2000. It provides the following:

1. Easy setup of DTS Modules.
DTS Web Server is menu driven. That is, it permits a user to simply select the function(s) to be modified from a pull down menu. Setup of a DTS Module usually requires only a few mouse clicks.
2. Command and configuration information may be sent to DTS Modules from a disk file.
This permits a very fast setup of a DTS Module. This is especially helpful when a module is to be modified during a test.
3. Display temperature values as numbers and in bar graph format.
This permits easy setup of a module or group of modules. All data are displayed.
4. Display "scrolled" data from DTS Modules.
When this window is opened, all communications from the DTS Modules are displayed.
5. Write data from DTS Modules to a disk file.
Permits storage of data in a format specified during setup.

The Web Server is designed to be connected to, and communicate with, one module. If it is necessary to connect to more than one module at a time, then multiple copies of the browser can be opened. The number of modules that can be supported at one time is dependant upon the processor speed and available memory of the Host PC.

Web Server Operation

Connect the DTS to a PC or onto a network. The IP address of the DTS must be in the same class as the PC or Network. The Ethernet cable must be a cross cable if connecting directly to a PC, or a straight connection if connecting to a hub.

This section has examples of the screens in the web browser. For these examples, the module IP address is 191.30.50.50. The address of a user's DTS3250 will most likely be different from this one. The user should substitute the IP address of the module being used wherever the IP address is mentioned

Launch Netscape Navigator, the version must be 4.74 or newer. When the browser is open, enter the following URL:

[Http://191.30.50.xxx/index.htm](http://191.30.50.xxx/index.htm)

Where: xxx is the serial number of the unit. If the IP address has been changed, use that address.

The DTS Home page will open. It will be similar to the one below.

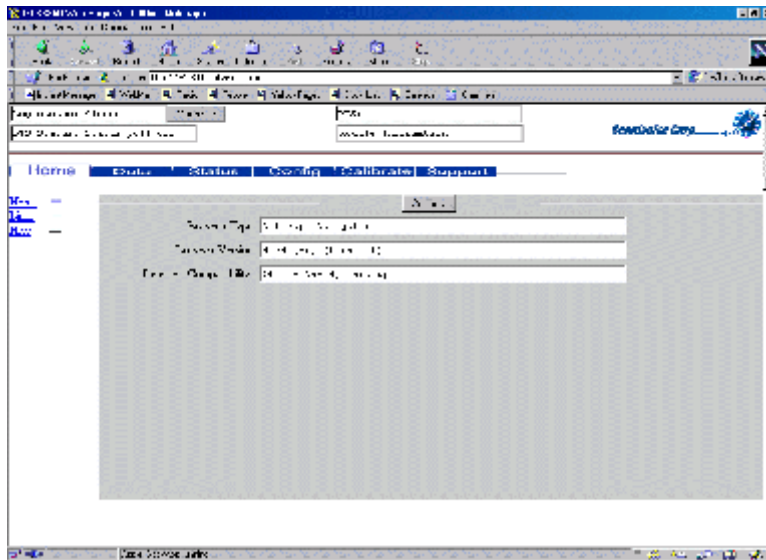

Home

The Home page offers the options to tab to one of five other pages or connect to the DTS. The other pages contain listings of the configuration variables that may be changed by a user.

The other available pages are:

Config	The Configuration page has three sub pages:	
	<u>Scan</u>	This page lists the most commonly modified scan configuration variables.
	<u>Type</u>	This page contains the Thermocouple variables and labels
	<u>General</u>	This page contains the Titles
Status	This page contains the Error list. Channel information will be added in a later release.	
Data	This page contains the functions related to starting and stopping the scan, and displaying the data. It has four sub pages.	
	Values	This is the main page. The data are shown in place.
	Bar	This function is not enabled
	Line	This function is not enabled
	Log	This is the set up page for logging data to disk.
Calibrate	This page is not active yet. It will contain all of the variables and functions required to calibrate the module.	
Support	This page opens a TelNet screen.	

Connect to the DTS by clicking Connect.

The Title information will be loaded and, if the DTS is functioning correctly, the DTS Status will indicate Ready.

NOTE: Do not enter commands until the DTS Status indicates: READY

The options for the Home page are listed on the left side.

Links

Links will permit a user to connect to the Scanivalve Web Site, www.scanivalve.com, if the user is connected to the Internet.

Help

This page has a link to the embedded Help file. This file contains information on commands, configuration variables, packet configurations, and thermocouple reference information. When this file is opened, scroll to, and click on, the command or variable in question. The browser will jump to the description of the term.

Config

The Config page contains the variables for Scan, Thermocouples, and General information. For more information regarding configuration variables, please refer to the software section of this manual.

Scan

This page would be used to:

1. Set the frame average
2. Set the period or channel interval
3. Select the number of averaged frames to be output when a Scan command is issued.
4. Select the Engineering Units
5. Select the time stamp time base.
6. Set the data format.
7. Enable an external trigger.

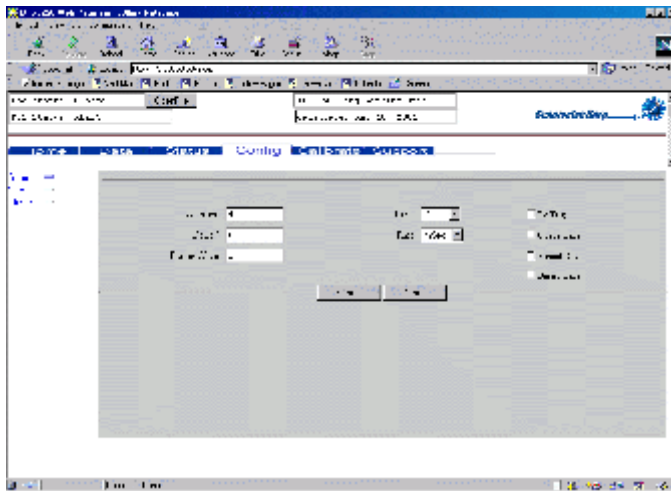

To change a value:

- Click in the window to display the cursor
- Enter the new value and click Submit.

If the window has an arrow to indicate that a pull down menu is available:

- Click on the down arrow
- Click on the desired value to highlight it
- Click Submit

If the variable has a check box:

- Click on the box to check or un-check the variable
- Click Submit

Type

This page will permit the user to

1. Select the thermocouple type
2. Identify the thermocouple with a unique label
3. Enable alarm limits
4. Set the alarm limits
5. Select the shield termination

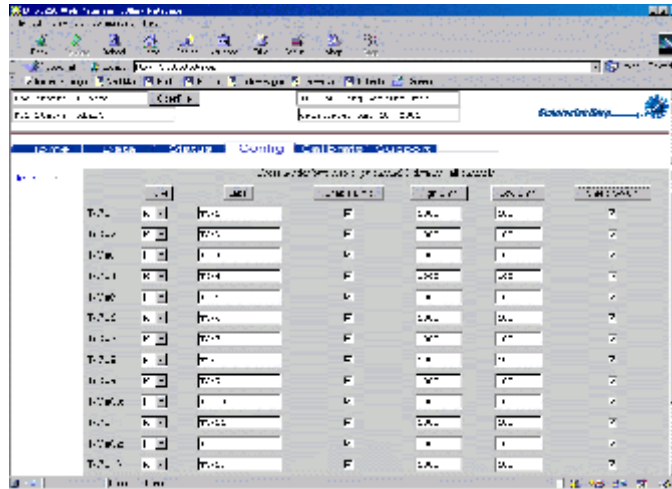

To change a value:

- Click in the window to display the cursor
- Enter the new value and click Submit.

If the window has an arrow to indicate that a pull down menu is available:

- Click on the down arrow
- Click on the desired value to highlight it
- Click Submit

If the variable has a check box:

- Click on the box to check or un-check the variable
- Click Submit

General

This page shows the Title1 and Title2 entries

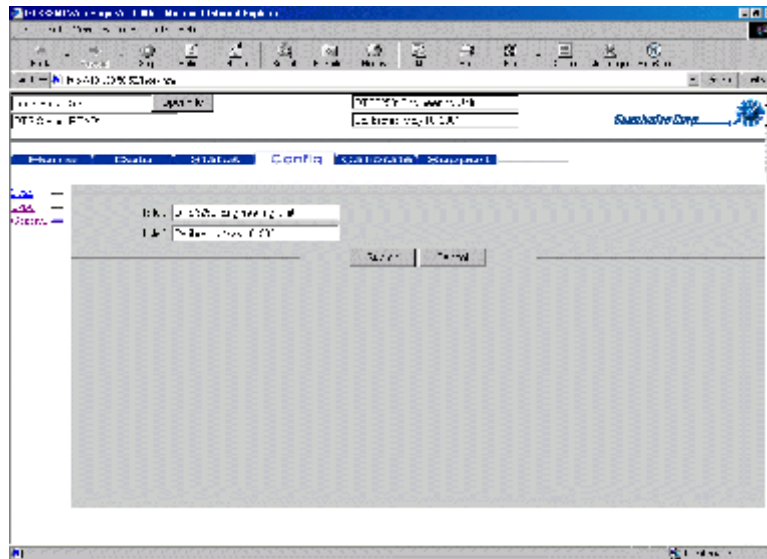

To change a value:

- Click in the window to display the cursor
- Enter the new value and click Submit.

Status

The Status page can be used to display the status of the module. It is divided into two sub-pages: Error and Channel

Error

This page will display the error buffer. The error buffer will hold the last 15 errors. Click on Update Errors to update the list. Clicking on Clear Errors will clear the Error Buffer.

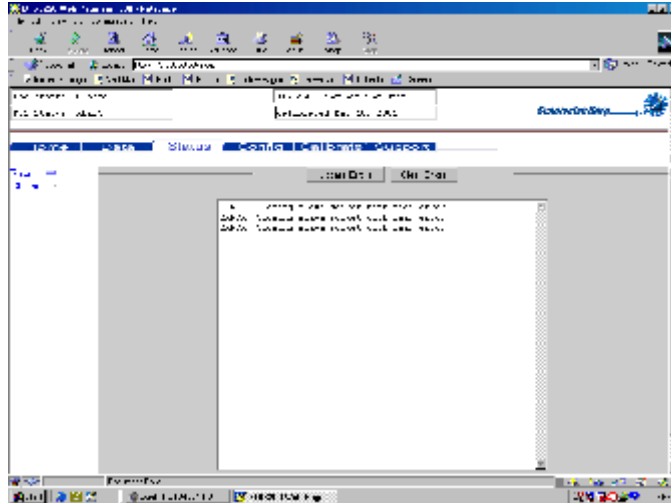

Channel

This feature is not enabled. It will display the status of the individual channels.

Data

This page will display the data from the Thermocouple channels. It provides buttons for some of the more common commands.

Values

Buttons

Scan	This button will start the scan function
Stop	This button will stop the scan function
OTC	This button will execute the Open Thermocouple Test
AD Cal	This button will re-zero the A/D's

Windows

Frame	This window shows the data frame being displayed
Units	The display units
Time	The time in milliseconds or microseconds since the scan function commenced
RTD1	The UTR temperature measured by RTD1
RTD2	The UTR temperature measured by RTD2

Data Display

The data display is 16 windows showing the value returned for each channel during the frame displayed in the frame window.

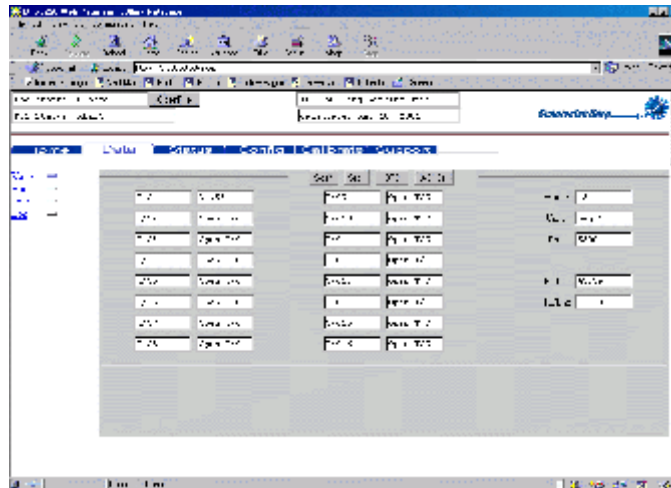

To change a value:

- Click in the window to display the cursor
- Enter the new value and click Submit.

If the window has an arrow to indicate that a pull down menu is available:

- Click on the down arrow
- Click on the desired value to highlight it
- Click Submit

If the variable has a check box:

- Click on the box to check or un-check the variable
- Click Submit

Bar	This function is not enabled
Line	This function is not enabled



Click on the Custom Level Button. The Security Settings Window will open.

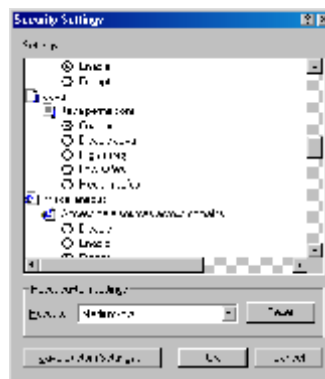

Scroll down to Java Permissions, Click the Custom Radio Button and then, Click on the Java Custom Settings Button

When the Local Internet Permissions Window opens, Click on the Edit Permissions Tab.



Find the Run Unsigned Content Listing and Click on the Enable Radio button. Click on the View Permissions Tab

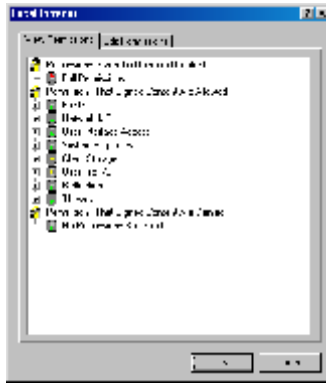

Verify that the Permissions Given to Unsigned content has a red indicator on the Full Permissions Line

Close all of the windows and return to the Web Browser by Clicking on the OK Button in each window.

Netscape Navigator Setup

These instructions are valid for V4.74. Other versions of Netscape Navigator may require additional or different steps.

The security levels for this version of Netscape Navigator are contained in a file named prefs.js. There may be multiple copies of this file on the local hard disk.

In the Windows Taskbar

- Select: Start
 - Select: Find
 - Select: Files or Folders
 - Enter: press.js in the Named box and click Find Now
- The search may show several copies of this file in different directories.

Using a Text Editor, such as Notepad, enter the following line in each of the files and save the revised file:

```
user_pref("signed.applets.codebase_principal_support", true);
```

The placement of this line is not critical. Netscape Navigator will sort the file.

Data Log Setup

- From the Data window, select Log
- When the Log window opens,
 - Enter the directory where the log file will be written.
 - Enter the name of the file
 - Check the Formatted Data box if Format is set to 1 and select the delimiter to be used.
- Click Submit to update the configuration in the DTS module

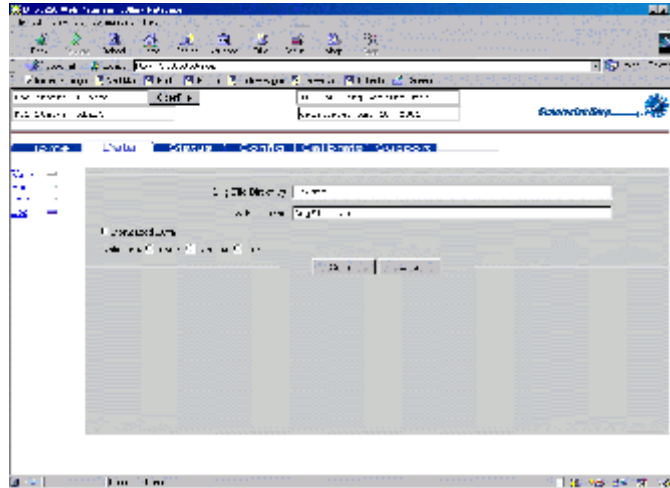

Open Log File

To open the log file, Click the Open Log button in the upper frame.

The Log Status will show the name of the log file and the button will change to CloseFile

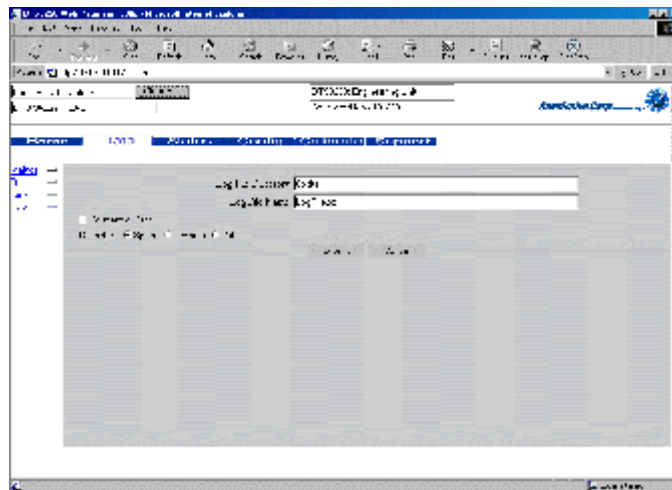

To close the Log File, Click the CloseFile button.

Bar This function is not enabled

Line This function is not enabled

Calibrate

This page is not enabled

Support

Telnet Clicking this link will open a TelNet Session. Enter commands in the upper window. The response from the DTS will be displayed in the bottom window.

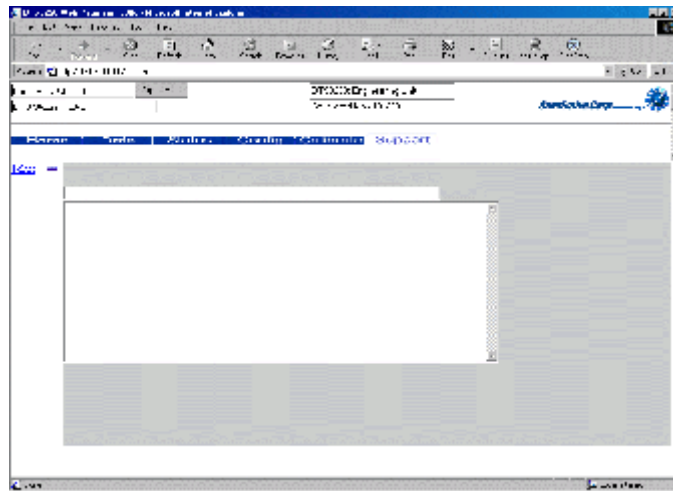

DTS3250 Boot Parameter Modification

The DTS3250 Series modules use an operating system licensed from VxWorks. The boot parameters are set at the factory, but these parameters may be modified to suit the needs of a specific installation. This section documents the modification of the boot parameters.

1. De-energize the DTS3250. Connect the DTS3250 trigger/serial test cable (Scanco part #155829) from the DTS3250 to a host PC.
2. Start HyperTerminal, or an equivalent communication program. Connect the DTS3250 to a COM port on the PC Host. Set the serial parameters to 9600 BAUD, no parity, 8 data bits and 1 stop bit.
3. Energize the DTS3250. The following sign-on information should be displayed.

```
VxWorks System Boot
Copyright 1984-1997 Wind River Systems, Inc.
```

```
CPU: HITACHI hs7709
Version: 5.3.1
BSP version: 1.1/0
Creation date: Feb 9 2000, 12:41:05
```

```
Scanivalve (c)2000, Boot loader version 1.01
Press any key to stop auto-boot...
```

4. Press any key within 3 seconds to stop the auto-boot process. If a key is not pressed within the 3 seconds time, the system will proceed to auto-boot with the existing operating system using the current setup.

NOTE: The boot-loader will continue to reboot until stopped by pressing a key under the following conditions:

- A. If boot-from-flash is selected, and no operating system is present in flash.
 - B. if boot-from-net is selected and the FTP server is not correctly set up.
5. When the auto-boot process is stopped, the boot-loader will prompt with:

```
[VxWorks Boot]:
```

To get a list of the existing boot parameters:

```
Type: p <Enter>
```

The following list is the default setup:

```
boot device           : cs
processor number      : 0
host name             : host
file name            : c:/dsa_hs/vxWorks.st
inet on ethernet (e) : 191.30.80.100
host inet (h)        : 191.30.101.109
user (u)             : DSA_HS
ftp password (pw)    : scanivalve
flags (f)            : 0x0
other (o)            : flash,000.096.093.218.000.002,10baseT
```

6. Modify the parameters as required by typing the change command at the [VxWorks Boot] prompt

Type: c<Enter> The boot-loader prompts you for each parameter.

If a particular field has the correct value and does not need to be changed,

Press: <Enter>

NOTE: If any other key is pressed, that will replace the existing information.

To clear a field,

Type: . <Enter>

To quit before viewing all of the parameters,

Type: CTRL+D.

7. After all changes have been made, verify the settings:
Type: p<Enter> The settings are saved in flash at this point.
8. Restart the operating system, with the new settings,
Type: @<Enter> This is the "Load and Go" command.
9. If the DTS3250 boots correctly, de-energize the DTS3250 and disconnect the serial test cable.
10. Re-apply power to the DTS3250.

Boot parameters and their functions:

boot device	Must not be changed from cs
processor number	Must not be changed from 0
host name	Must not be changed from host.
file name	The full pathname of the operating system file name to be booted from, when booting from the network. The default path and file in this line is the path and file used at Scanivalve.
inet on ethernet(e)	The IP address of this DTS3250. The subnet mask may be specified when entering this parameter by entering a colon followed by the subnet mask in hex notation. I.e. 191.30.85.100:FFFFFF00
inet on backplane (b)	Must be left blank
host inet (h)	The IP address of the host for boot or file upload
gateway inet (g)	The IP address of a gateway node if the host is not on the same network as the DTS3250.
user (u)	The user name that the DTS3250 uses to access the host. This is the name that must be set up in the FTP server on the host. The FTP server must be set up to provide that user name with the proper permission to read from the host directory and the password must be set correctly.
ftp password (pw)	The user password. This must be supplied to boot from host.
flags (f)	Must be 0x0
target name (tn)	Must be blank
startup script (s)	Must be blank
other (o)	This specifies the place to boot from, the MAC address, and the network media. The line must not contain any spaces and each parameter is separated by a comma. The syntax is: <bootloc>,<mac address>,<media type> Valid values are case sensitive and are as follows: <bootloc> net - Boot from network flash - Boot from flash. <mac address> ddd.ddd.ddd.ddd.ddd.ddd <media type> 10base2 - 10Base2 type 10baset - 10BaseT type

DTS3250 Operating System Upload

This section describes the method for upgrading and uploading a new operating system to the DTS3250. Two programs are used in the DTS3250, the boot-loader and the operating system/DTS3250 application, referred to as the operating system.

The purpose of the boot-loader is to start the operating system from local flash or from a location on the network, such as a disk file on a host PC and to allow setting of certain key operating system parameters. The boot-loader can only be installed with special flash programming equipment. However, the boot-loader, under most normal upgrade conditions, would not need to be changed.

When upgrading a new DTS3250 operating system, the following procedure should be followed:

1. Install an FTP server, on your host PC. Scanivalve Corp recommends the War Daemon FTP Server. The installation is described in the FTP Server Installation/Configuration Procedure.
2. Use the boot parameter modification procedure to modify the boot parameters:
 - A. Change the file name parameter to the location of the vxWorks.st file.
 - B. Change the host IP address to match the host computer.
 - C. Insure that the user parameter is set to DSA_HS. It must match the user in the FTP server. This name may be modified by a user
 - D. Set the password to scanivalve. It must match the password in the FTP server. The password may be modified by a user.
3. Connect to the DTS3250 using TelNet
4. Issue the "UPLOAD S <full file path>" command from TelNet. Only back slashes can be used in the path name and the S must be upper case.
5. Monitor the operation with the STATUS command. When it returns READY, the upload is complete. The upload will require about 2.5 minutes to complete. If READY is returned immediately, something has been entered incorrectly.
6. When the DTS3250 returns READY, The new operating system is installed in flash memory, but not in RAM.
7. The new operating system will be effective when power is recycled.

DTS3250 Buffer Description

The DTS3250 buffer is a software buffer. It is set up as a FIFO. It is factory set to hold 10000 averaged frames of data. Each frame uses 292 bytes of memory.

The software buffer is always in use regardless of the setting of QPKTS variable. The effect of QPKTS occurs when the buffer is filled. If QPKTS is set to 1, the scan will stop when the buffer is full. If QPKTS is set to 0, subsequent frames will be discarded when the buffer is full.

The buffer is the liaison between the scan task and the scan output task. The scan output task has a higher priority than the scan task. Under initial conditions, when the buffer is empty, the scan task places one frame of data in the buffer. It then signals the scan output task to read the buffer until it is empty. However, when multiple frames of data are in the buffer, the output task continues until the buffer is empty. Multiple frames of data will accumulate if the scan output task is blocked by the network while outputting data.

WarFTP Server

Installation

- Copy the file: Warftp.exe into a temporary directory.
 - Double click: Warftp.exe to unzip the installation files.
 - Double click: Setup.exe
- A window will open prompting for an installation directory. Click Next.

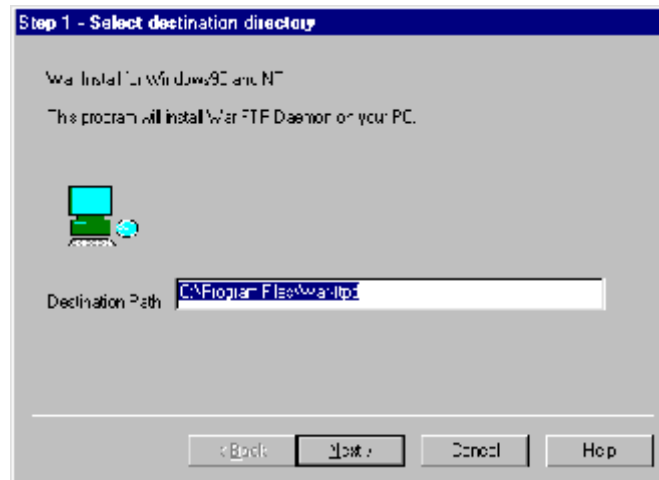

- A window will open prompting for an installation type.
Select: Typical, and click Next.

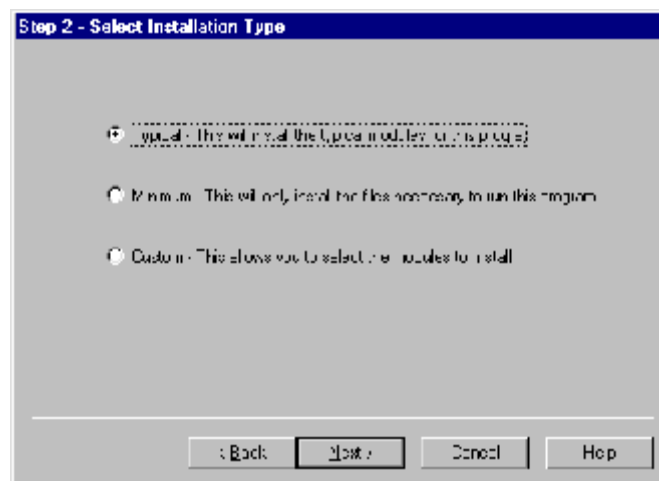

A Window will open prompting for a program folder. Use the default folder, and click Next.

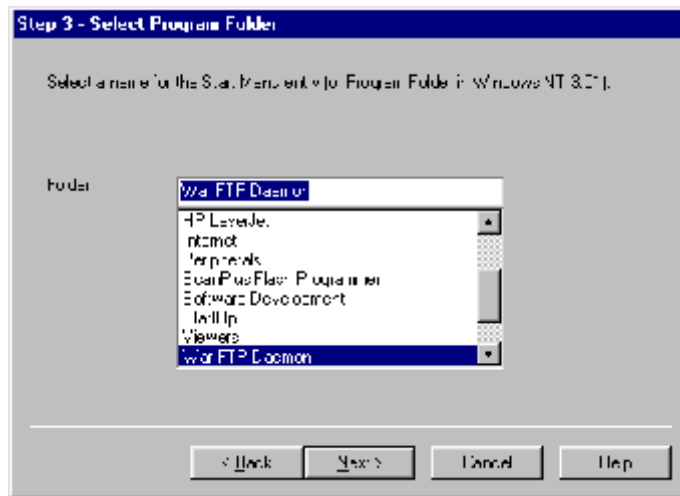

A window will open prompting to finish the installation.

Click: Finish to complete the installation.



If the installation is successful, a window will open with this message. Click OK



Create a folder for the DTS files.

Create the directory: C:\DTS_HS.

Copy the file: VxWorks into this directory.

Configuration and Setup

Start the application by double clicking the war-ftp.exe icon in the C:\Program Files\War-ftp directory.

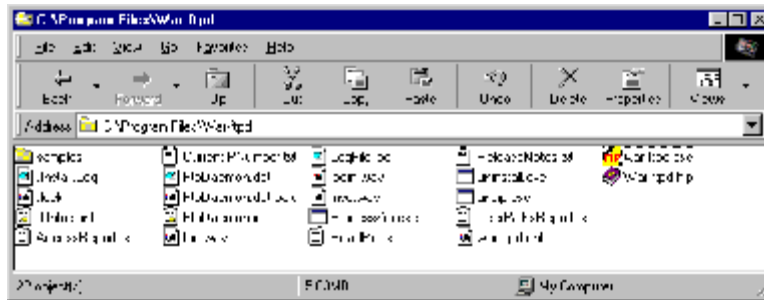

The War FTP Daemon information window will open

Enable the "Do not show this banner again" check box and click OK.



The main display window will open. It will look similar to the window below.

Select: Properties

Select: Options

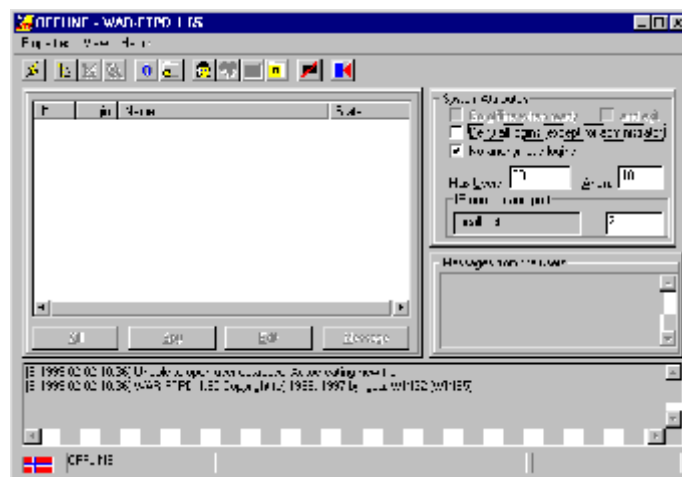

From the General Tab, Enable the "Go online when started and minimize" check boxes.
Select the Server Name Tab.

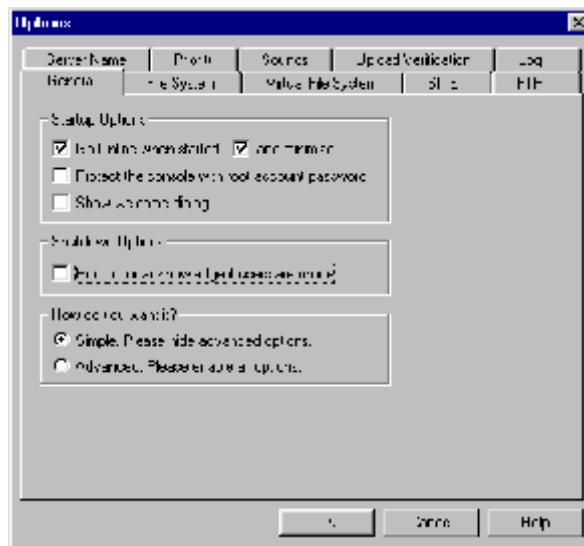

Enter a name for the FTP server.
In this example the server will be named : host.
Click OK.

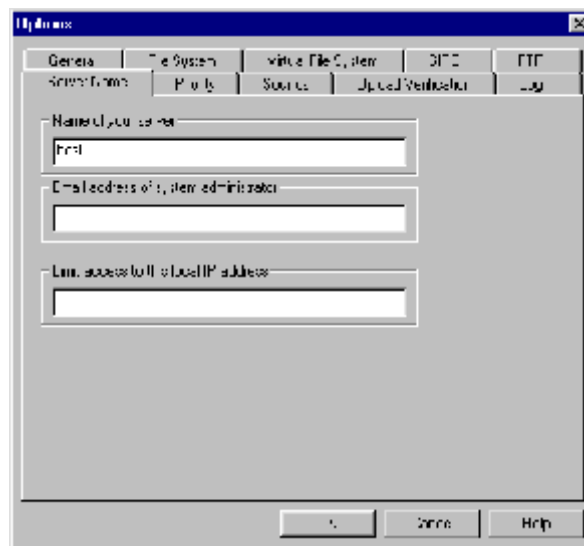

The main window will re-open
Open the User Maintenance window:

Click on the large smiling face icon

When the User Maintenance Window opens,

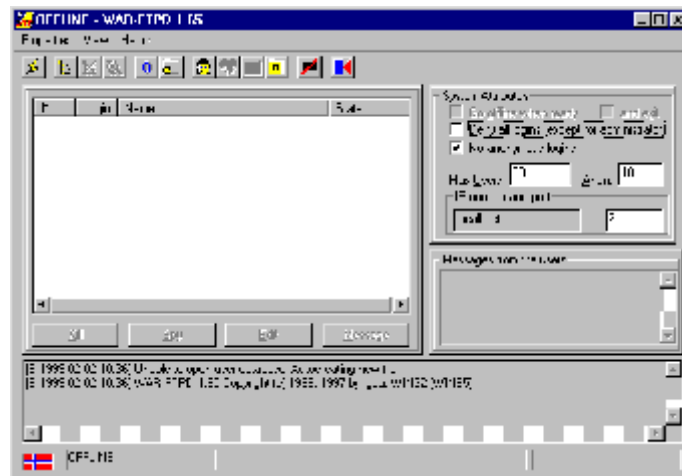

Click the Add button

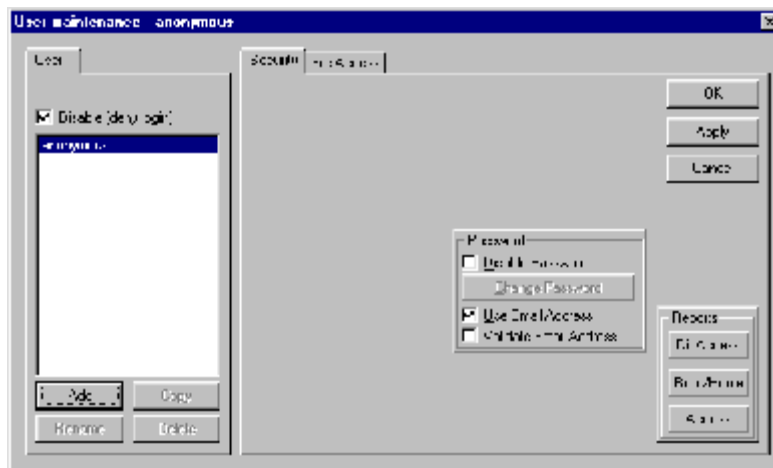

A window will open prompting a User name for the DTS

Enter a user name for the DTS.

For this example, the User Name will be: DTS_HS

Click OK.

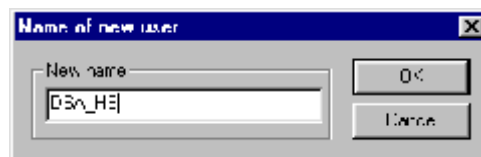

Another window will open prompting for a password

Enter a password for the DTS.

For this example, the password will be: scanivalve.
Click OK.

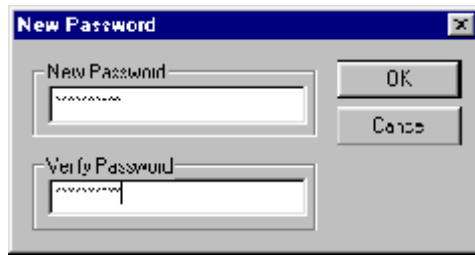

The User Maintenance window will re-open.
Highlight DTS_HS
Select the File Access Tab
Click on the Add Button.

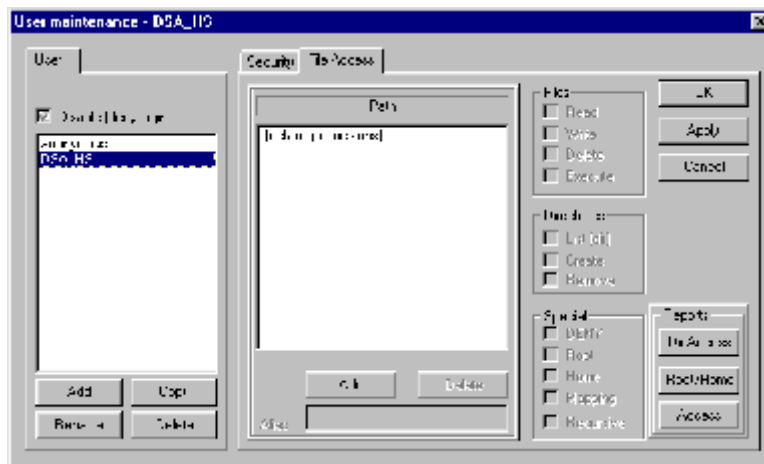

A Select Directory Window will open
Highlight the DTS_HS directory.
Click OK.

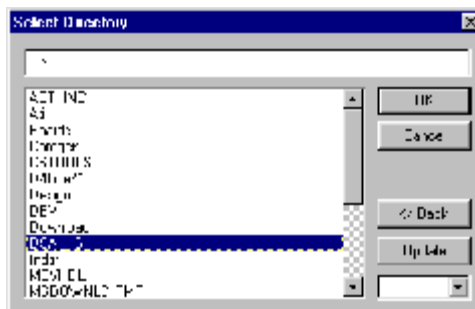

Enable the Read and Write checkboxes in the Files frame.
Click : Apply
Click: OK

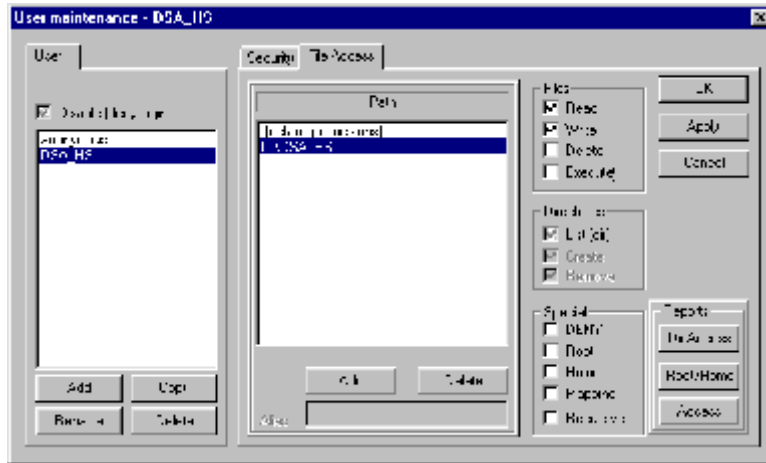

The Main Window will re-open
 Put the server online:
 Click on the lightning bolt..

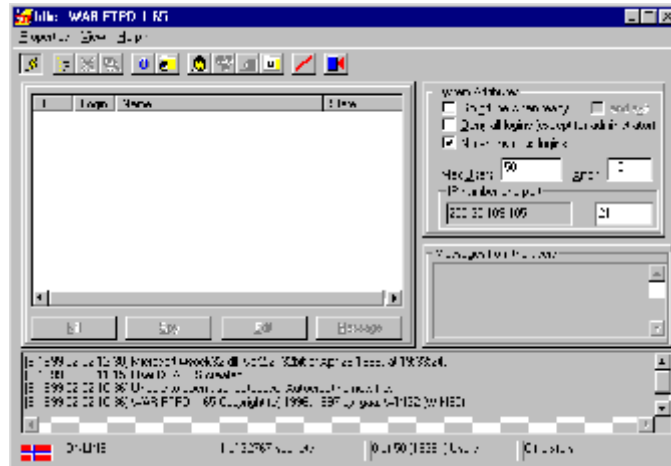

The WarFTP server is now ready
 The server can be started manually as needed, or it could be configured to start automatically by placing a shortcut to War-Ftpd.exe in the Windows/Start Menu directory.

Appendix A - Accessories

Power Supply - PDM 1000

A single output 24 Vdc power supply is available as an accessory to the DTS3250. This power supply will drive one DTS3250. The Scanivalve part number is 145065-1. The unit will operate from 100 to 240 Vac at 47 to 63 Hz. The output is 24 Vdc at 2.5 A. A 10 foot (3 meter) interconnecting cable, Scanivalve part number 155819-1, is included. Longer cables are available. For more information on the power supply and cables, contact Scanivalve Corp, Customer Service Department.

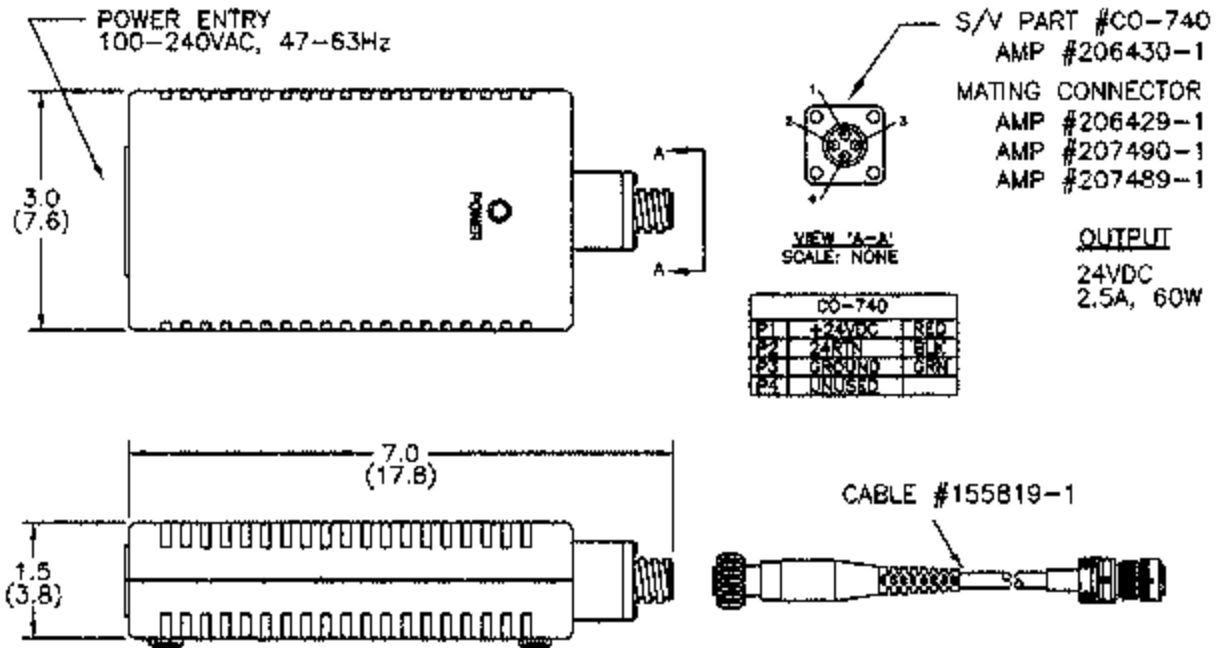

Power Supply - PDM 3200

For users with multiple DTS3250 units, A 24 Vdc power supply capable of powering multiple units is available. This power supply will drive up to four DTS3250s. The Scanivalve part number is 21080-1. The unit will operate from 88 to 264 Vac at 47 to 63 Hz. Each output is 24 Vdc at 2.5 A. Interconnecting cables are not included, but mating connectors are provided. Scanivalve Corp will manufacture interconnecting cables, if requested. A standard 10 foot (3 meter) interconnecting cable, Scanivalve part number 155819-1, is available. Longer cables are available on request. For more information on the power supply and cables, contact Scanivalve Corp, Customer Service Department.

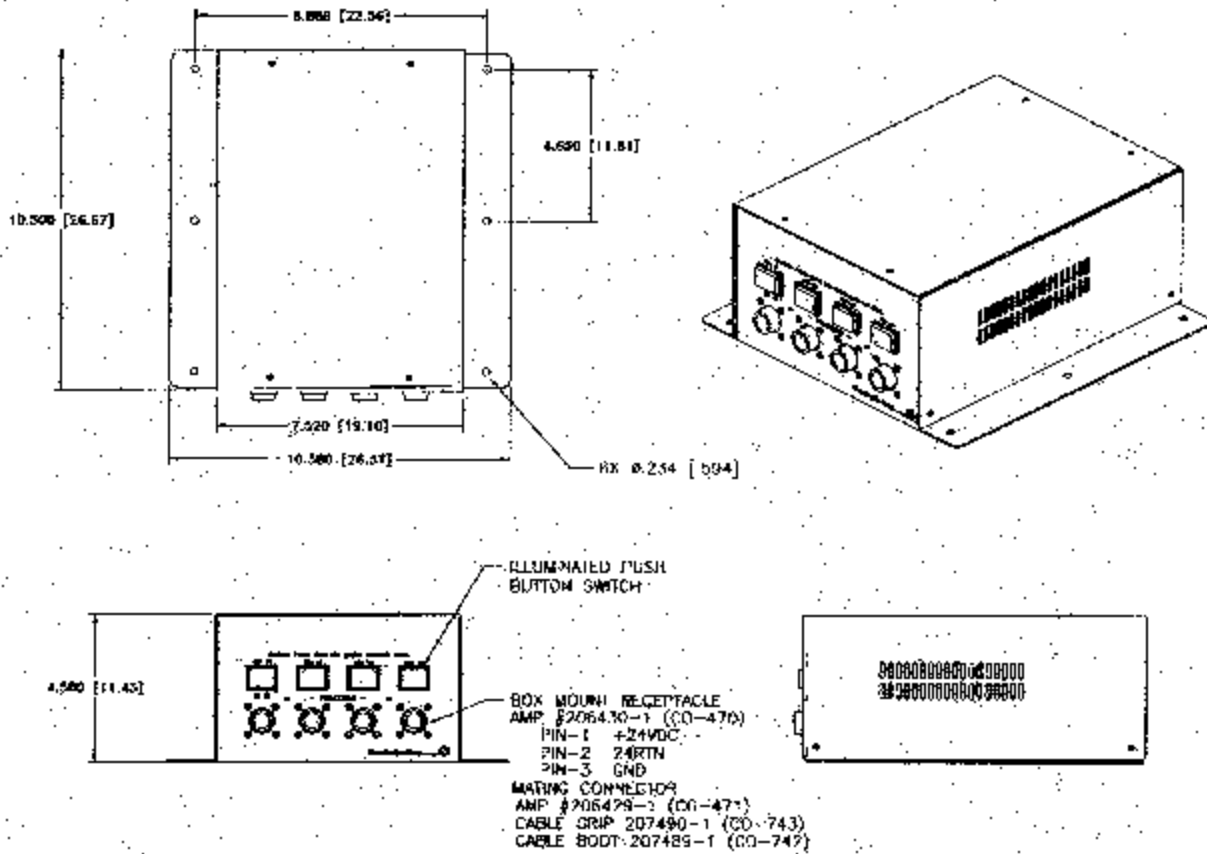

Appendix B - Thermocouple Information

Thermocouple Basics

When two dissimilar metals are joined together to form a closed loop, and if one junction is held at a different temperature from the other, an Electromotive Force (EMF) is generated. The amount of EMF generated is predictable based on the materials used and the temperature of the junction.

The EMF is generated by the wires, not the junction. A temperature gradient must exist before the EMF can be generated.

Three laws have been established that govern thermoelectric circuits.

Law of Homogeneous Materials

A thermoelectric current cannot be sustained in a circuit of a single homogeneous material, however it varies in cross section, by the application of heat alone.

Simply stated, two different materials are required for any thermocouple circuit. If current can be detected in a homogeneous wire when it is heated, this is evidence that the wire is inhomogeneous.

Law of Intermediate Materials

The algebraic sum of the thermoelectromotive forces in a circuit composed of any number of dissimilar materials is zero if all of the circuit is at a uniform temperature.

This law states that a third homogeneous material can be added to a circuit with no effect on the net EMF of the circuit as long as temperature of the junctions remain the same.

Law of Successive or Intermediate Temperature

If two dissimilar homogeneous materials produce a thermal EMF of E_1 when the junctions are at temperature T_1 and T_2 , and a thermal EMF of E_2 when the junctions are at T_2 and T_3 , the EMF generated when the junctions are at T_1 and T_3 will be $E_1 + E_2$.

This law states that a thermocouple calibrated for one reference temperature can be used with any other reference temperature with a correction. Also, extension wires having the same characteristics as those of the thermocouple wires can be introduced to the circuit without affecting the circuit.

Thermocouple Circuits

A basic thermocouple circuit consists of two dissimilar homogeneous materials extending from the measuring junction to the reference junction.

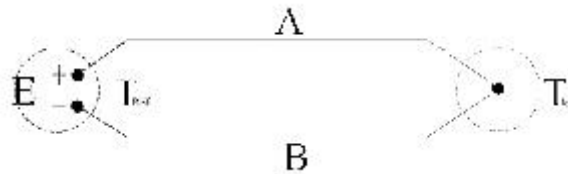

When more than one thermocouple is to be measured, each thermocouple should be two continuous wires between the measuring and reference junctions. This is the most common circuit for thermoelectric testing.

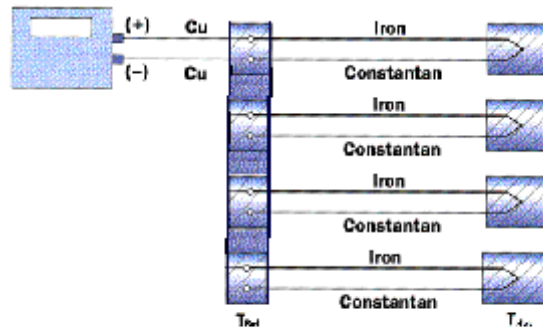

Thermocouple Accuracy

Thermocouple accuracy can be defined as relative and absolute accuracy.

Relative Accuracy

This is the ability of the system to repeat a given measurement. This depends upon the quality of the sensors, the measuring system used and how the system is installed.

Absolute Accuracy

This is the ability of the system to determine a standard accepted value. This can be achieved by calibration relative accepted and recognized standards.

Thermocouple Calibration

Calibration will not change the characteristics of a thermocouple. It does validate the system and ensure proper readings by allowing corrections to be entered for each thermocouple in the system. Calibrations should conform to ISO 10012-1:1992.

Sources of Error in Thermocouple Measurements

Measuring Junction

The thermocouple junction at the temperature measuring point is the measuring junction. Errors at this point depend upon the age of the junction, the method of joining and materials used to form the junction. Generally, errors from the measuring junction are small.

Extension Wires

Extension wires are any elements inserted between the measuring junction and the reference junction. Extension wires should have the same characteristics as the thermocouple wire. Extension wires introduce four junctions to each circuit. This can cause errors as large as ± 2 EC. The errors can be minimized by calibrating the system with the extension wires in place. If possible, extension wires should not be used.

Reference Junctions

The thermocouple junction maintained at a known temperature is the reference junction. Reference junctions can introduce errors as large as ± 0.6 EC.

Copper Connecting Wires

These wires are used to connect the reference junction to the measuring device. The errors caused by these wires are very small.

Thermocouple Switches

When used, these devices can induce errors as large as ± 1 EC. Switching should occur in the copper wires between the reference junction and the measuring device.

Noise in Thermocouple Circuits

The external effects that can cause errors in thermocouple circuits include: electrical and magnetic fields, cross-talk, and common mode voltage.

Electric fields radiated from voltage sources are capacitively coupled to thermocouple extension wires. This imposes an AC voltage on the thermoelectric EMF. This can be minimized by shielding the thermocouple extension wire and grounding the shield.

Magnetic fields produce noise current in the thermocouple extension wire. This can be minimized by twisting the thermocouple extension wire pairs.

In a multipair thermocouple extension wire, adjacent pairs can pick up noise from a pulsating signal. This can be minimized by shielding the individual pairs.

Common mode noise will be generated if a grounded thermocouple is connected to a grounded instrument. This can be minimized by grounding the thermocouple and shield as close as possible to the measuring point.

Thermocouple Design

The thermocouple used in an application should be selected specifically for the application.

Size

The temperature sensed will be the average temperature across the length of the sensor.

Shape

The shape must conform to the shape of the surface if the thermocouple is measuring surface temperatures.

Response

The response time of a thermocouple is mass dependent. Therefore the size of the thermocouple must be small in relation to the object being measured. The response time should be approximately 5 times shorter than the fastest rate of temperature change to be monitored.

Heat Conduction

Thermocouple extension wires can conduct heat into or out of the thermocouple. The wire must be insulated from the environment if this can occur.

Sensor Position

The thermocouple measures the temperature of the object it is touching or the environment in which it is installed. Therefore the thermocouple must be positioned very carefully to insure that the temperature is being sensed at the correct point.

Thermocouple Types and Descriptions

The DTS family of Temperature Scanners will accept inputs from Type E, J, K, N, R, S, and T Thermocouples. The accuracy of the measurement will depend upon the type of thermocouple and the quality of the extension wire used for the measurement.

Type E - Chromel Constantan

Positive leg	90% nickel, 10% chromium
Negative leg	43% nickel, 57% copper
Range	-270 to 1000 EC
Usable range	0 to 900 EC
Notes	Highest EMF output per degree of all recognized thermocouples. Has similar drift between 316 and 593 EC as a Type K thermocouple

Type J - Iron Constantan

Positive leg	100% iron
Negative leg	43% nickel, 57% copper
Range	-210 to 1200 EC
Usable range	0 to 816 EC
Notes	Not susceptible to aging from 371 to 538 EC. Very stable, should be used with a 96% pure MgO insulation and stainless steel sheath to prevent corrosion of the iron lead. Most commonly used thermocouple.

Type K - Chromel Alumel	
Positive leg	90% nickel, 10% chromium
Negative leg	95% nickel, 2% aluminum, 2% manganese, 1% silicon
Range	-270 to 1372 EC
Usable range	-36 to 1260 EC
Notes	Not recommended from 316 to 593 EC because of aging that can cause drift rates of 2 EC in a few hours. Best used when corrosion may be a problem.
Type N	
Positive leg	14% chromium, 1.4% silicon, 84.6% nickel
Negative leg	95.6% nickel, 4.4% silicon
Range	-270 to 1372 EC
Usable range	0 to 1260 EC
Notes	Less aging from 316 to 593 EC than a Type K thermocouple.
Type R	
Positive leg	87% platinum, 13% rhodium
Negative leg	100% platinum
Range	-50 to 1767 EC
Usable range	0 to 1482 EC
Notes	Has a higher output than Type S thermocouples. Easily contaminated. This thermocouple should be protected by compacted mineral insulation and a metal outer sheath.
Type S	
Positive leg	90% platinum, 10% rhodium
Negative leg	100% platinum
Range	-50 to 1767 EC
Usable range	0 to 1482 EC
Notes	Easily contaminated. This thermocouple should be protected with a gas tight ceramic tube, a secondary tube of porcelain and a silicon carbide or metal outer tube.
Type T - Copper Constantan	
Positive leg	Pure copper
Negative leg	43% nickel, 57% copper
Range	-270 to 400 EC
Usable range	-262 to 350 EC
Notes	Good for low temperature and cryogenic applications

International Thermocouple and Extension Wire Color Codes

Country	USA	USA	United Kingdom	United Kingdom	Germany	Japan	France
Standard	ANSI MC96.1 T/C	ANSI MC96.1 Extension	BS 1843	BS 4937	DIN 43714	JIS C1610-1981	NFE C42-323
E Overall E Positive E Negative	Brown Purple Red	Purple Purple Red	Brown Brown Blue	Brown Brown Blue	Black Red Black	Purple Red White	-----
J Overall J Positive J Negative	Brown White Red	Black White Red	Black Yellow Blue	Black Black White	Blue Red Blue	Yellow Red White	Black Yellow Black
K Overall K Positive K Negative	Brown Yellow Red	Yellow Yellow Red	Red Brown Blue	Green Green White	Green Red Green	Blue Red White	Yellow Yellow Purple
N Overall N Positive N Negative	Brown Orange Red	Orange Orange Red	-----	-----	-----	-----	-----
R Overall R Positive R Negative	-----	Green Black Red	Green White Blue	Orange Orange White	White Red White	Black Red White	Green Yellow Green
S Overall S Positive S Negative	-----	Green Black Red	Green White Blue	Orange Orange White	White Red White	Black Red White	Green Yellow Green
T Overall T Positive T Negative	Brown Blue Red	Blue Blue Red	Blue White Blue	Brown Brown White	Brown Red Brown	Brown Red White	Blue Yellow Blue

Appendix C - DTS 3250 Calibration Procedure

Introduction

The DTS3250 is a very accurate and stable microvoltmeter. It measures the microvolt input from a thermocouple, corrects the input for the “cold junction” temperature, and converts this voltage to a temperature value. Of all of the functions, the measurement of the “cold junction” temperature is the most critical. It is recommended that a DTS3250 be re-calibrated every six months to insure the best accuracy. Calibration intervals may be extended if “as received” measurements show the unit to be in tolerance at successive six month checks. Failure to use calibration standards with the specified accuracy or failure to follow this procedure carefully, will result in large errors.

Equipment Required

Secondary Voltage Standard. Accuracy equal to or better than ± 1.5 FV from -10 mV to 131 mV dc
Digital Volt/Ohmmeter Accuracy equal to or better than ± 10 FV from 95 mV to 105 mV dc
100 ohm Standard Resistor with a measured value accurate to $\pm 0.001\%$

Ice Point Reference

Thermocouple Simulator

DTS Hardware and Software Manual

Scanivalve Field Calibration Kit - Scanco Pn 21090-70, Consisting of:

- 155870-1 DTS Calibration Board Set (a)
- 155872-1 Thermocouple Bridge Cable (b)
- 155873-1 RTD Voltage Cal Cable (c)
- 155874-1 Voltage Input Cable (d)
- 155868-1 DTS RTD Extension Cable
- 155869-1 RTD Measurement Cable
- 21089-1 Calibration Insulation

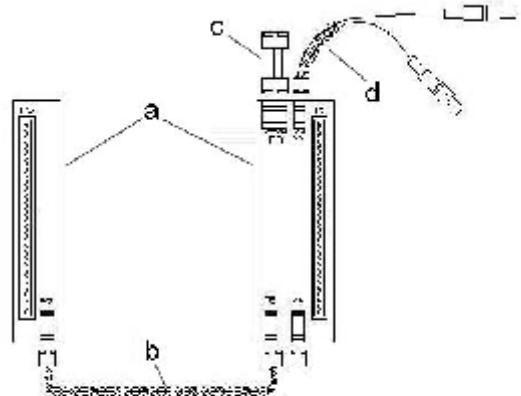

Figure A

Warning: It is very important that proper ESD precautions are followed when the DTS calibration board set is being installed or removed, or whenever cables are connected and disconnected.

Procedure

1. Energize the DTS and allow a minimum of 4 hours for warm up. When changing connections or configurations, it is recommended that a user wait 30 minutes for every minute the DTS is open to room temperature.

6. Enter the RTD calibration coefficients.

These coefficients are generated from a calibration by a certified lab or the manufacturer of the RTD. Each RTD will have its own unique set of coefficients. The DTS can support up to 8 coefficient data points.

It may not be necessary to install new coefficients. Manufacturers of RTD's specify that the maximum drift of an RTD over one year will be less than $\pm 0.05\%$ per year. If new coefficients are not available, then the original coefficients will be used for this step.

To enter New coefficients, Type:

```
SET RTDP <RTD> <index> <temp> <Ohms><Enter>
```

Where: RTD is the RTD number, 1 or 2
Index is the data point number, 0 to 7
Temp is the calibration temperature in degrees C
Ohms is the resistance of the RTD at the calibration temperature

If new coefficients are not entered then the existing coefficients must be verified.

Verify that the coefficients stored in the DTS either match the coefficients stored during the original calibration or have been entered correctly.

Type: List RTDP x<Enter> Where: x is 1 for RTD 1 coefficients and 2 for RTD 2 coefficients.

For Example, the coefficients for RTDs calibrated at three(3) temperatures might appear as follows:

```
SET RTDP 1 0 0 99.99  
SET RTDP 1 1 100 138.46  
SET RTDP 1 2 41.8 116.18  
SET RTDP 2 0 0 99.93  
SET RTDP 2 1 100 138.40  
SET RTDP 2 2 41.8 116.14
```

NOTE: The actual coefficients **MUST** match the coefficients for the RTD. Also the number of coefficient data points **MUST** match the entries in step 5.

RTD Circuit Calibration

7. Remove the RTD access plates by removing the 6 screws holding each plate in place. Refer to Figure B for more information. Figure C shows the location of the RTD's and the calibration connectors

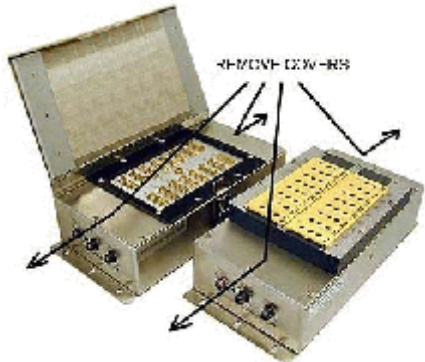

Figure B



Figure C

8. Measure the RTD excitation current.
NOTE: At least one RTD must be connected to the DTS signal board to perform the following RTD Excitation Measurement procedure.

Disconnect RTD1 from the circuit board and using the RTD Excitation Measurement Cable, Scanivalve part number 155869-1, connect a 100 Ohm resistance standard in series with the excitation circuit of RTD 1.

Note: Do not pull on the RTD wires when disconnecting the harness from the DTS signal board. Use needle nose pliers or equivalent to remove the connector from the board.

The test setup is shown in figure F.



Figure F

Measure the voltage across the resistance standard.

Divide this voltage by the known resistance of the standard to determine the excitation current. Enter this value into the DTS using the following command:

SET RTDX1 <I> Where: I is the measured current, in milliamps.

Disconnect the RTD Extension Cable from the RTD 1 input. Re-connect RTD 1. Disconnect RTD 2 and connect the RTD Extension Cable to the RTD2 input and repeat the excitation current measurement. The command for entering the RTD 2 excitation is:

SET RTDX2 <I>

Save the values of RTDX1 and RTDX2

SAVE

NOTE: These values should be between 0.95 and 1.05. The combined error of the resistance standard and DVM should be less than .005% or this procedure may increase the DTS error. If this equipment is not available, set RTDX1 and RTDX2 to 1.

9. Referring to Figure A, Connect the Thermocouple Bridge Cable to P5 and P7 of the Calibration Board Set. Connect the RTD Voltage Calibration Cable to P3. Connect the Voltage Input Cable to P2. Disconnect RTD1 from the DTS and connect the RTD Voltage Calibration Cable (Refer to Figure C). Install the Calibration Board Set in the Calibration Connectors, making sure that the splice in the Voltage Input cable is positioned as shown in Figure D.

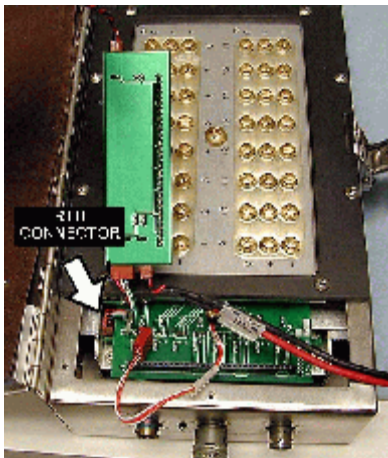

Figure D

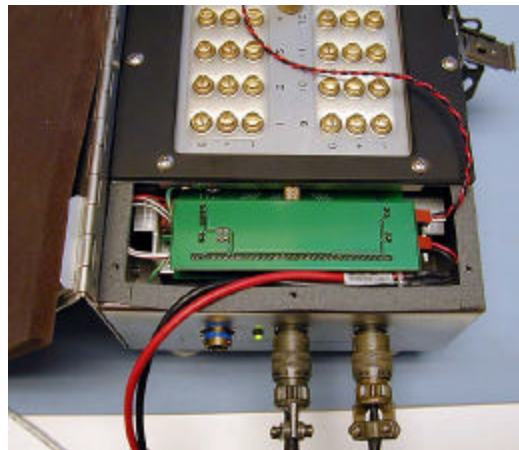

Figure E

10. Install the RTD Voltage Cal cable in P2 of the calibration board and connect it to the RTD1 input. Disconnect the RTD from J1
11. Connect the voltage standard to the RTD Input and route the cable with the splice inside box and cover with insulation. Close the cover and allow 30 minutes for warmup.
NOTE: The splice must be in the box and covered with the insulation or large errors may result. Figure E shows the proper placing of the splice. Figure G shows the proper placing of the insulation.

12. Verify the response of the RTD circuits. Only one RTD will respond to the changes in input voltage.

Type: Scan<Enter>

The DTS will return data scans in the following format:

Frame=0000000

Rtd1=1530998 Rtd2=1530437 Units=Raw

01= -270952 02= -270950 03= -270949 04= -270952 05= -270932 06= -270962
 07= -270952 08= -270952 09= -270952 10= -270936 11= -270951 12= -270982
 13= -270920 14= -270979 15= -270922 16= -270966

Apply the voltages listed in the following table and verify that the RTD raw count values are with the limits shown. Only RTD1 will respond to the voltage changes.

Table 1

Applied Voltage	Ideal Counts	Low Limit	High Limit
95.000 mV	1287022	1272022	1302022
115.000 mV	1557974	1542974	1572974
131.000 mV	1774736	1759736	1789736

13. Calibrate the RTD Inputs.

The A/D converters have a feature that will correct for span and zero drift. This is initiated by the ADCAL command.

Disconnect the Voltage Input Cable from the Voltage Standard and re-zero the A/D converters.

Type: ADCAL

When the DTS autostatus returns READY:

Type: ERROR

If the DTS returns:

ERROR: A/D Timeouts, or

ERROR: MADCAL

The DTS has a hardware problem. Contact Scanivalve Corp, Product Support Department for instructions.

If the DTS returns:

ERROR: No Errors

Connect the Voltage input cable to the voltage standard and inject a series of voltages to calibrate the RTD inputs.

Set the Voltage standard to output 95 mV and enter the following command:

RPT x y Where: x is the data point, 0 through 7
 y is the voltage applied in volts.

The DTS autostatus feature will return CAL. Wait until the status is reported as READY and repeat this command for each of the data points and voltages listed in table 2.

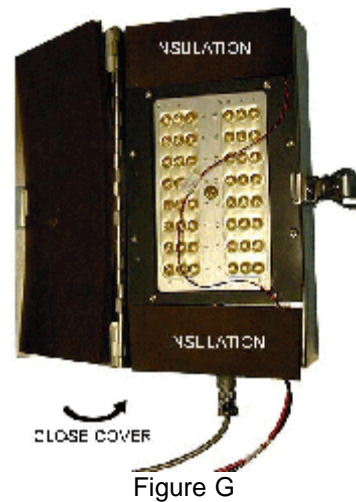

If a point is mis-entered, do not attempt to backspace or re-type the entry. Enter the point as typed and wait until the STATUS is reported as: READY. Then, re-enter the point.

Table 2

Data Point (x)	Voltage (y)
0	.095
1	.100
2	.105
3	.110
4	.115
5	.120
6	.125
7	.131

When all of the data points have been entered, Verify the entries.

Type: List RPT<Enter>

The DTS will return the RPT data points. A typical set of data points are shown below for reference only. These values will be different from the Unit being calibrated.

```

SET RPT 0 0.095000 1270934
SET RPT 1 0.100000 1338769
SET RPT 2 0.105000 1406385
SET RPT 3 0.110000 1474005
SET RPT 4 0.115034 1541736
SET RPT 5 0.120035 1609322
SET RPT 6 0.125068 1676981
SET RPT 7 0.131070 1758227

```

Generate the RTD coefficients

Type: Fill

Save the coefficients.

Type: Save

14. Verify the calibration by inserting voltages between the calibration setpoints.

Type: Set Units V<Enter> This will set the output to volts

Type: Scan<Enter> This will start the scan

Apply the voltages listed in table 3 and verify that they are within the limits listed. Allow the Voltage Standard to stabilize before verifying the values.

NOTE: Only RTD1 will respond.

Table 3

Applied Voltage	Low Limit	High Limit
97.500 mV	97.455 mV	97.545 mV
102.500 mV	102.455 mV	102.545 mV
107.500 mV	107.455 mV	107.545 mV
112.500 mV	112.455 mV	112.545 mV
117.500 mV	117.455 mV	117.545 mV
122.500 mV	122.455 mV	122.545 mV
128.000 mV	127.955 mV	128.045 mV

If the data are not within the limits listed, repeat the calibration.

If the data are within the limits listed, Save the calibration.

Type: SAVE<Enter>

15. Make sure that the RTDs are connected.

Type: FILL This will generate a fit to these points.

Type: SET UNITS C This will set the DTS output to degrees C

Type: SCAN

The DTS scan output may appear as follows:

Frame=0000028 Time=11500 ms

Rtd1= 31.92 C Rtd2= 31.87 C Units=C

01= 21.63 02= 9999.99 03= 9999.99 04= 9999.99 05= 9999.99 06= -9999.99
 07= 9999.99 08= 9999.99 09= 9999.99 10= -9999.99 11= -9999.99 12= 9999.99
 13= -9999.99 14= -9999.99 15= -9999.99 16= -9999.99

The two RTD readings should agree within ± 0.1 degrees, if the DTS is stable. The UTR can have gradients of several tenths of a degree if it is not insulated properly.

If the RTD 1 and RTD 2 data are within the limits listed, Save the calibration.

Type: SAVE<Enter>

The steps completed to this point have calibrated the RTD circuits only.

16. Verify the Thermocouple raw count readings.

Disconnect the RTD Voltage Cal Cable from the module

Re-connect the RTD1 cable

Connect the Voltage Standard to P4

Start Scanning

Type: SCAN

Inject the voltages listed in Table 4

Table 4

Applied Voltage	Ideal Counts	Low Limit	HighLimit
-10.000 mV	-270952	-285952	-255952
0.000 mV	0	-15000	15000
70.000 mV	1896664	1881664	1911664

Verify that all of the thermocouple channels are within the limits specified.

17. If all of the thermocouple channels respond properly, proceed with the calibration of the individual channels. The PT command is used to enter the channel setpoints.

Disconnect the Voltage Input Cable from the Voltage Standard and re-zero the A/D converters.

Type: ADCAL

When the DTS autostatus returns READY:

Apply the voltages in the Table 5. At each point,

Type: PT <x> <y><Enter> Where: x is the data point, 0 to 7
Y is the applied voltage in volts

Table 5

Data Point	Voltage
0	-.010000
1	0
2	.012000
3	.024000
4	.036000
5	.048000
6	.060000
7	.070000

18. Verify the Thermocouple Channel conversion.

Generate the coefficient tables.

Type: Fill

Set the DTS output to volts

Type: Set Units V

Disconnect the Voltage Input Cable from the Voltage Standard and re-zero the A/D converters.

Type: ADCAL

When the DTS autostatus returns READY:

Start Scanning
Type: Scan

Apply the voltages listed in table 6 and verify that each channel indication is within the specified limits.

Table 6

Voltage	Low Limit	High Limit
-5.000 mV	-5.006 mV	-4.994 mV
0.000 mV	-0.006 mV	0.006 mV
6.000 mV	5.994 mV	6.006 mV
18.000 mV	17.994 mV	18.006 mV
30.000 mV	29.994 mV	30.006 mV
42.000 mV	41.994 mV	42.006 mV
54.000 mV	54.994 mV	54.006 mV
65.000 mV	64.994 mV	65.006 mV

19. If all of the data are within specifications. Save the calibration.

Type: Save

NOTE: If a save command is not executed before power is removed from the unit, the calibration data will be lost.

20. This completes the calibration
Close the TelNet session.
De-energize the DTS.
Remove the calibration fixture
Re-install the cover plates.

Appendix D - Change Log

Version 2.00 - Released March 2001
First Release

Version 2.01 - Released March 2001
Added a Software Trigger Function
Modified several default values to facilitate initial factory calibrations
Modified the response of the software to a SET Value command if the Value is not changed
Added STATUS returns when in the Binary mode
Added variables to better calibrate the RTD's
RTDP
RTDNUMPT
RTDNUMCOEF
RTDX1
RTDX2
Added a command to list the new variables
LIST RTDP
Added capability to send Binary data out the TelNet port
Improved the accuracy of the conversion algorithm

Version 2.02 - Released April 27,2001
Improved the stability of the RTD readings
Added a debug switch input for troubleshooting new boards

Version 2.03 - Released June 2001
Added the AUTOSTATUS command
Added SET TYPE to the mode list
Added Range features
Added Limits for alarms
Increased the speed of SET PERIOD
Added Labels for the T/C channels
Added Titles
Corrected a bug in the ASCII format and un-formatted decimal alignments
Improved the RTD conversion algorithm
Set the Output socket to non-blocking at data out
Added REBOOT command

Version 2.04 - Released June 28, 2001
Added an embedded web server
Corrected a bug in the SET PERIOD routine

Version 2.05 - Released August 22, 2001
Expanded the functions of the web server